

# CONTACTORES - LINEA CWM

Alta tecnología y seguridad



Motores | Automatización | Energía | Transmisión & Distribución | Pinturas



# Contadores - Linea CWM

## Sumario

Introducción	04
Visión General de Los Accesorios	05
Contadores Tripolares de 9 hasta 250 A (AC-3) - Bobina CA	10
Contadores Tripolares de 40 hasta 105 A (AC-3) - Bobina CC	11
Contadores Tripolares de 112 hasta 800 A (AC-3) - Bobina con Módulo Electrónico CA/CC	12
Contadores Tetrapolares - Bobinas CA o con Módulo Electrónico CA/CC	13
Accesorios	14
Repuestos	20
Características Técnicas	21
Dimensiones (mm)	42

## Contadores CWM - Introducción

Con capacidad de maniobrar cargas inductivas nominales hasta 800 A o 440 kW @ 380/400 V, WEG puede suministrar el contactor más adecuado para su aplicación.

Contadores CWM permiten optimización total de espacio en el tablero, con solamente algunos tamaños compactos es posible maniobrar potencias de 4 hasta 440 kW @ 400/415 V. Para reducir *stock*, los contactores CWM poseen accesorios comunes. Por ejemplo, los bloques de contactos auxiliares laterales son los mismos de 9 hasta 300 A (AC-3) @ 440 V.

Desarrollados para tener elevada vida eléctrica y mecánica, pueden ser utilizados en las más severas aplicaciones industriales. Todos los contactores WEG son testeados y aprobados para aplicaciones de acuerdo con las coordinaciones tipo 1 y tipo 2.

Para tener una aceptación global, todos los componentes están de acuerdo a las normas UL 508 (USA y Canadá), IEC/EN 60497 y CE.

Todos los contactores WEG son fabricados con procesos y materiales de alta calidad.

De esta manera, WEG ofrece soluciones para aplicaciones en baja tensión para tableros, fabricantes de equipo original, distribuidores y usuarios.



## Contactores CWM desde 9 hasta 40 A (AC-3) - Accesorios

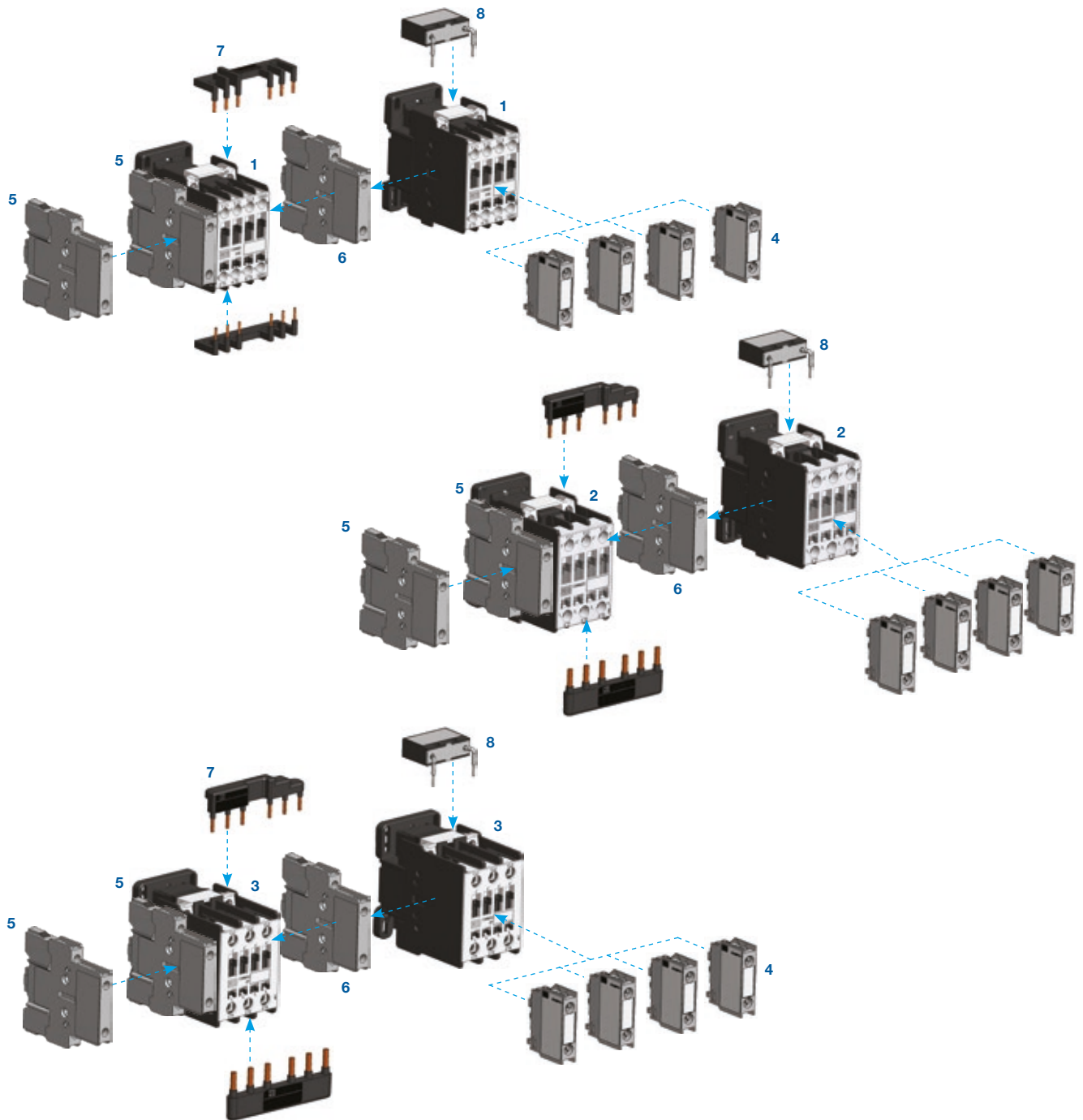

- 1 - Contactores CWM9...18
- 2 - Contactores CWM25
- 3 - Contactores CWM32/40
- 4 - Bloque de contacto auxiliar frontal BCXMF
- 5 - Bloque de contacto auxiliar lateral BCXML
- 6 - Enclavamiento mecánico BLIM
- 7 - Barras easy connection
- 8 - Supresor de sobretensión BAM

## Contactores CWM desde 50 hasta 105 A (AC-3) - Accesorios

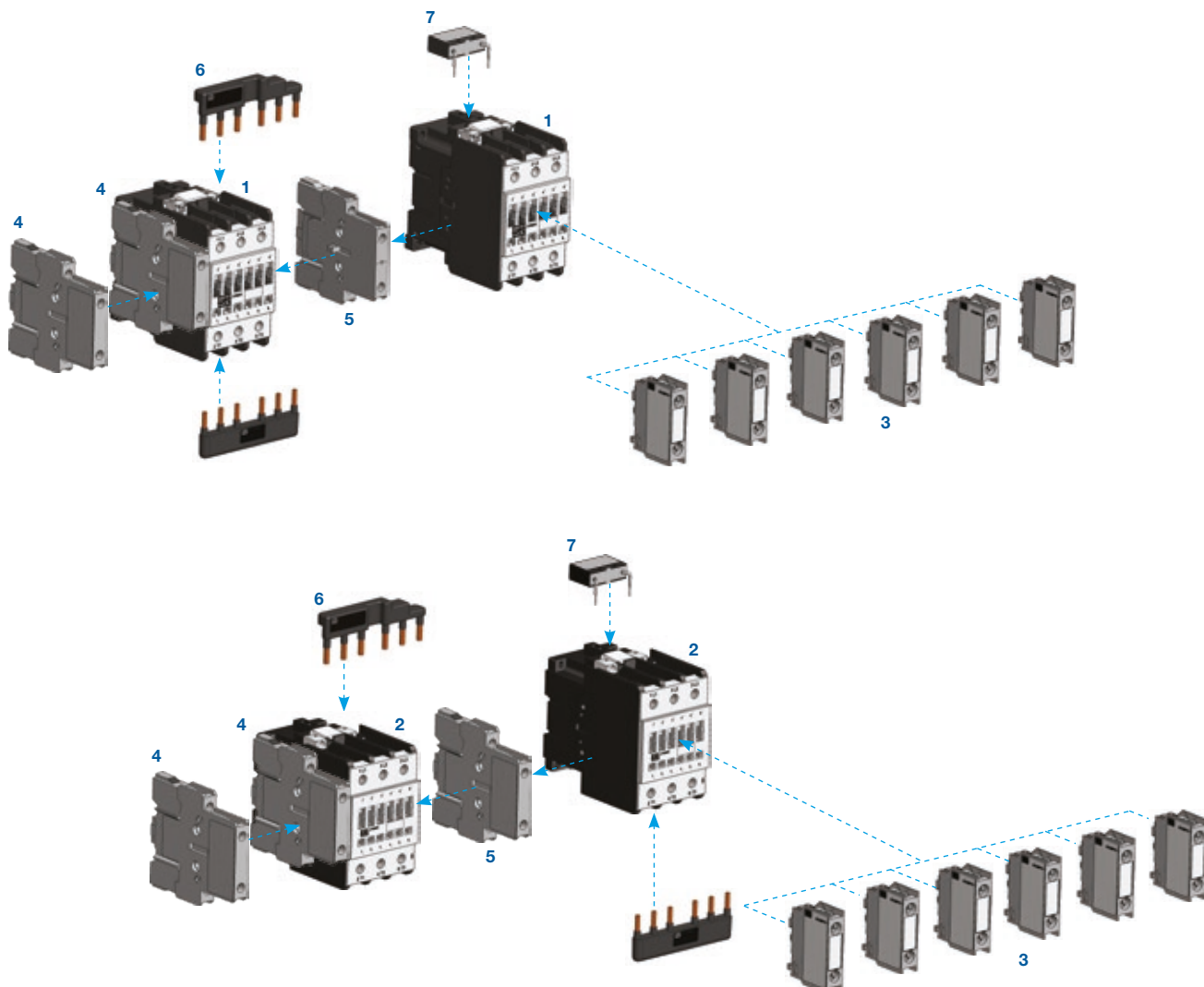

- 1 - Contactores CWM50...80
- 2 - Contactores CWM95/105
- 3 - Bloque de contacto auxiliar frontal BCXMF
- 4 - Bloque de contacto auxiliar lateral BCXML
- 5 - Enclavamiento mecánico BLIM
- 6 - Barras easy connection
- 7 - Supresor de sobretensión BAM

## Contadores CWM desde 112 hasta 300 A (AC-3) - Accesorios

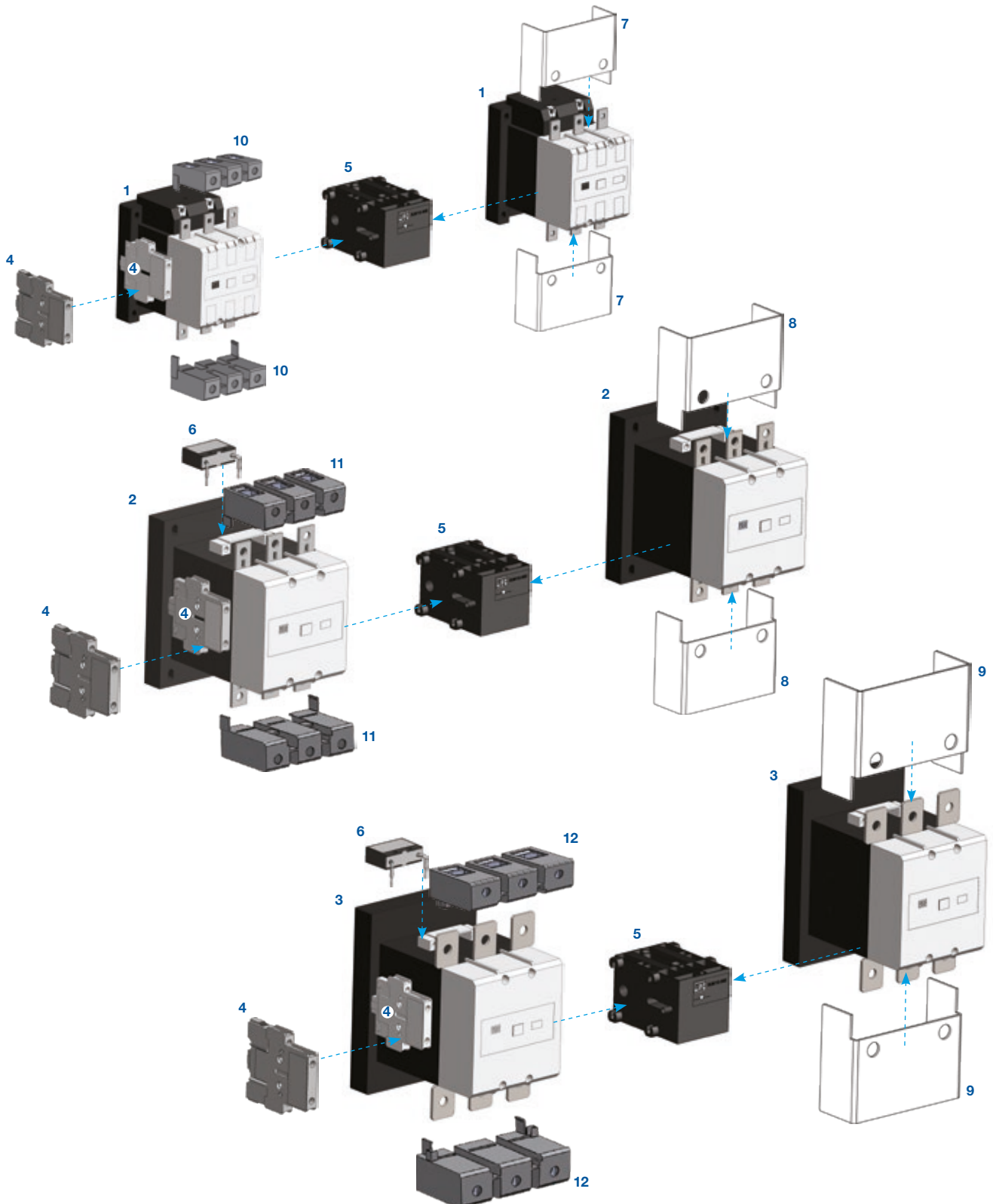

- 1 - Contactores CWM112/150
- 2 - Contactores CWM180/215
- 3 - Contactores CWM250/300
- 4 - Bloque de contacto auxiliar lateral BCXML
- 5 - Enclavamiento mecánico BLIM112-300
- 6 - Supresor de sobretensión BAMV

- 7 - Cubrebornes BMP CWM150
- 8 - Cubrebornes BMP CWM180
- 9 - Cubrebornes BMP CWM300
- 10 - Bloque prensacable TB150
- 11 - Bloque prensacable TB180
- 12 - Bloque prensacable TB300

## Contadores CWM450 y CWM560

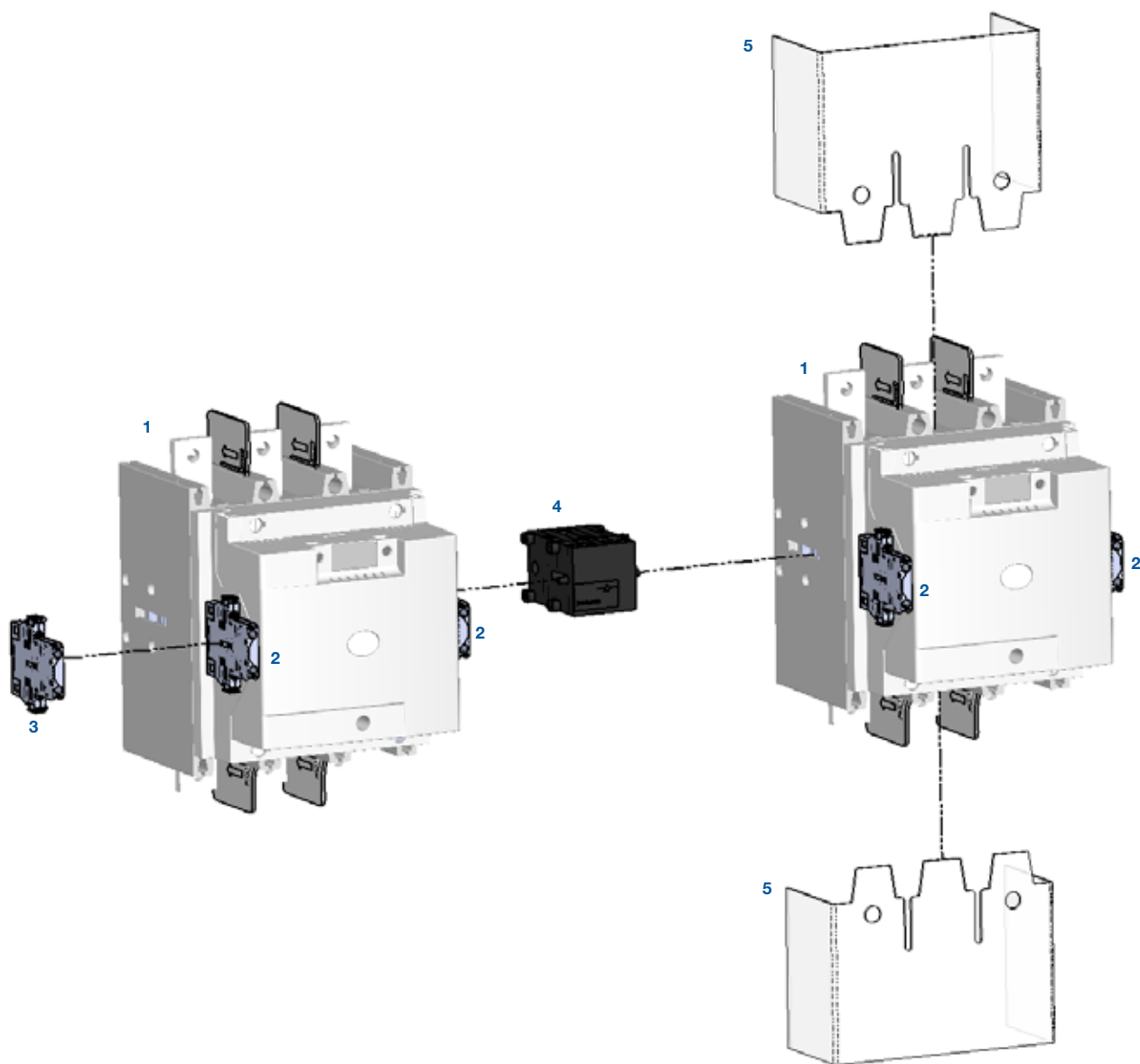

- 1 - Contactores CWM450/560
- 2 - Bloque de contacto auxiliar lateral BLB
- 3 - Bloque de contacto auxiliar lateral BLRB
- 4 - Enclavamiento mecánico BLIM112-300
- 5 - Cobrebornes BMP CWM560



## Contactores CWM400, CWM500, CWM630 y CWM800 (AC-3) - Accesorios

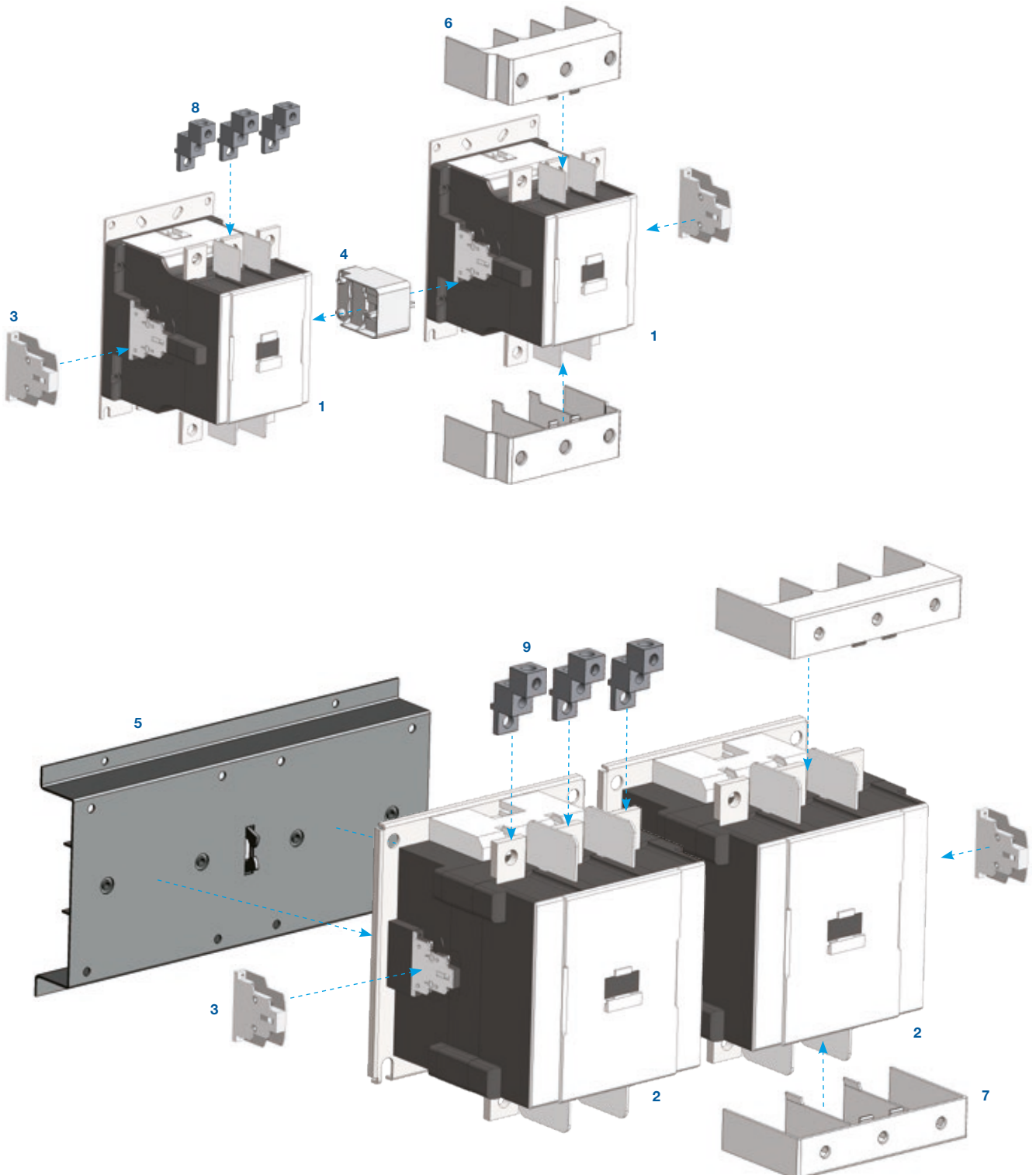

- 1 - Contactores CWM400
- 2 - Contactores CWM500 / CWM630 / CWM800
- 3 - Bloque de contactos auxiliares BCXML\*\* CWM800
- 4 - Enclavamiento mecánico BLIM CWM400
- 5 - Enclavamiento mecánico BLIM CWM800
- 6 - Cubrebornes BMP CWM400
- 7 - Cubrebornes BMP CWM800
- 8 - Prensacables BMJ CWM400
- 9 - Prensacables BMJ CWM800

## Contadores CWM - Tabla de Selección



### Contadores Tripolares de 9 hasta 250 A (AC-3) - Bobina CA<sup>3)</sup>

Corriente nominal de operación $I_n$ AC-3 ( $U_e \leq 440$ V)	Corriente térmica convencional $I_{th} = I_n$ AC-1	Potencia nominal máxima de operación motores trifásicos 50/60 Hz <sup>1)</sup>					Contactos auxiliares integrados en el contactor		Bloques de contactos auxiliares		Referencia para completar con el código de tensión de mando	Peso kg
		220 V 230 V	380 V 400 V	415 V 440 V	500 V	660 V 690 V	3 NA	1 NC	BCXMF10 NA	BCXMF01 NC		
9	25	2,2 / 3	3,7 / 5	4,5 / 6	4,5 / 6	5,5 / 7,5	1	0	-	-	CWM9-10-30♦	0,360
							0	1	-	-	CWM9-01-30♦	
							1	1	-	1	CWM9-11-30♦	
							2	2	1	2	CWM9-22-30♦	
12	25	3 / 4	5,5 / 7,5	5,5 / 7,5	5,5 / 7,5	7,5 / 10	1	0	-	-	CWM12-10-30♦	0,360
							0	1	-	-	CWM12-01-30♦	
							1	1	-	1	CWM12-11-30♦	
							2	2	1	2	CWM12-22-30♦	
18	32	4,5 / 6	7,5 / 10	9,2 / 12,5	9,2 / 12,5	11 / 15	1	0	-	-	CWM18-10-30♦	0,360
							0	1	-	-	CWM18-01-30♦	
							1	1	-	1	CWM18-11-30♦	
							2	2	1	2	CWM18-22-30♦	
25	45	5,5 / 7,5	11 / 15	11 / 15	11 / 15	11 / 15	0	0	-	-	CWM25-00-30♦	0,390
							1	0	1	-	CWM25-10-30♦	
							0	1	-	1	CWM25-01-30♦	
							1	1	1	1	CWM25-11-30♦	
32	60	9,2 / 12,5	15 / 20	15 / 20	15 / 20	18,5 / 25	2	2	2	2	CWM25-55-30♦	0,620
							0	0	-	-	CWM32-00-30♦	
							1	0	1	-	CWM32-10-30♦	
							0	1	-	1	CWM32-01-30♦	
40	60	11 / 15	18,5 / 25	22 / 30	22 / 30	22 / 30	1	1	1	1	CWM32-11-30♦	0,650
							2	2	2	2	CWM32-22-30♦	
							0	0	-	-	CWM40-00-30♦	
							1	1	1	1	CWM40-11-30♦	
50	90	15 / 20	22 / 30	30 / 40	30 / 40	30 / 40	2	2	2	2	CWM40-22-30♦	1,205
							0	0	-	-	CWM50-00-30♦	
							1	1	1	1	CWM50-11-30♦	
							2	2	2	2	CWM50-22-30♦	
65	110	18,5 / 25	30 / 40	37 / 50	37 / 50	37 / 50	0	0	-	-	CWM65-00-30♦	1,215
							1	1	1	1	CWM65-11-30♦	
							2	2	2	2	CWM65-22-30♦	
							0	0	-	-	CWM80-00-30♦	
80	110	22 / 30	37 / 50	45 / 60	45 / 60	45 / 60	1	1	1	1	CWM80-11-30♦	1,220
							2	2	2	2	CWM80-22-30♦	
							0	0	-	-	CWM95-00-30♦	
							1	1	1	1	CWM95-11-30♦	
95	140	22 / 30	45 / 60	55 / 75	55 / 75	55 / 75	2	2	2	2	CWM95-22-30♦	1,525
							0	0	-	-	CWM105-00-30♦	
							1	1	1	1	CWM105-11-30♦	
							2	2	2	2	CWM105-22-30♦	
105	140	30 / 40	55 / 75	55 / 75	55 / 75	55 / 75	0	0	-	-	CWM112-22-30♦	1,505
							1	1	1	1	CWM112-11-30♦	
							2	2	2	2	CWM180-22-30♦	
							2	2	-	-	CWM250-22-30♦	
112	180	30 / 40	55 / 75	55 / 75	55 / 75	75 / 100	2	2	-	-	CWM112-22-30♦	3,1
180	225	55 / 75	90 / 125	110 / 150	110 / 150	110 / 150	2	2	-	-	CWM180-22-30♦	51,0
250	350	75 / 100	132 / 175	150 / 200	150 / 200	150 / 200	2	2	-	-	CWM250-22-30♦	6,66

Reemplazar "♦" con el código de tensión deseado<sup>2)</sup>.

Bobina CA - 50/60 Hz												
Códigos de tensión de bobinas	D02	D07	D13	D23	D24	D25	D33	D34	D35	D36	D39	
V ca - 50/60 Hz	24	48	110	220	230	240	380	400	415	440	480	

Notas: 1) Los dimensionamientos presentados son válidos para motores WEG W22 Plus, IV polos, factor de servicio 1,0 y categoría de servicio AC-3.

Estos valores son orientativos y pueden cambiar de acuerdo con el número de polos o proyecto del motor.

2) Otras tensiones bajo consulta.

3) Para selección de accesorios, consulte la sección "Contadores CWM - accesorios".

## Contadores CWM - Tabla de Selección



### Contadores Tripolares de 40 hasta 105 A (AC-3) - Bobina CC<sup>4)5)</sup>

Corriente nominal de operación $I_e$ AC-3 ( $U_e \leq 440$ V)	Corriente térmica convencional $I_{th} = I_e$ AC-1	Potencia nominal máxima de operación motores trifásicos 50/60 Hz <sup>1)</sup>					Contactos auxiliares integrados en el contactor		Bloques de contactos auxiliares		Referencia para completar con el código de tensión de mando	Peso kg
		220 V 230 V (kW / HP)	380 V 400 V (kW / HP)	415 V 440 V (kW / HP)	500 V (kW / HP)	660 V 690 V (kW / HP)	$\begin{matrix} \cdot 3 \\   \\ \cdot 4 \end{matrix}$ NA	$\begin{matrix} \cdot 1 \\   \\ \cdot 2 \end{matrix}$ NC	BCXMF10 NA	BCXMF01 NC		
40	60	11 / 15	18,5 / 25	22 / 30	22 / 30	22 / 30	0	0	-	-	CWM40-00-30 ♦	0,640
							1	1	1	1	CWM40-11-30 ♦	
							2	2	2	2	CWM40-22-30 ♦	
50	90	15 / 20	22 / 30	30 / 40	30 / 40	30 / 40	0	0	-	-	CWM50-00-30 ♦	1,463
							1	1	1	1	CWM50-11-30 ♦	
							2	2	2	2	CWM50-22-30 ♦	
65	110	18,5 / 25	30 / 40	37 / 50	37 / 50	37 / 50	0	0	-	-	CWM65-00-30 ♦	1,463
							1	1	1	1	CWM65-11-30 ♦	
							2	2	2	2	CWM65-22-30 ♦	
80	110	22 / 30	37 / 50	45 / 60	45 / 60	45 / 60	0	0	-	-	CWM80-00-30 ♦	1,463
							1	1	1	1	CWM80-11-30 ♦	
							2	2	2	2	CWM80-22-30 ♦	
95	140	22 / 30	45 / 60	55 / 75	55 / 75	55 / 75	0	0	-	-	CWM95-00-30 ♦	1,463
							1	1	1	1	CWM95-11-30 ♦	
							2	2	2	2	CWM95-22-30 ♦	
105	140	30 / 40	55 / 75	55 / 75	55 / 75	55 / 75	0	0	-	-	CWM105-00-30 ♦	1,463
							1	1	1	1	CWM105-11-30 ♦	
							2	2	2	2	CWM105-22-30 ♦	

Reemplazar "♦" con el código de tensión deseado<sup>2)3)</sup>.

Códigos de tensión de bobinas (CWM40...105)	C34	C37	C40	C44
V cc	24-28	42-50	110-130	208-240

Notas: 1) Los dimensionamientos presentados son válidos para motores WEG W22 Plus, IV polos, factor de servicio 1,0 y categoría de servicio AC-3.

Estos valores son orientativos y pueden cambiar de acuerdo con el número de polos o proyecto del motor.

2) Otras tensiones bajo consulta.

3) No es necesaria la utilización de supresores de sobretensión para contactores CWM40-105 con bobina CC.

4) Para selección de accesorios, consulte la sección "Contactores CWM - Accesorios".

5) Para corrientes menores que 40 A (AC-3) utilizar la nueva línea CWB9...38.

## Contadores CWM - Tabla de Selección



### Contadores Tripolares de 112 hasta 300 A (AC-3) - Bobina con Módulo Electrónico CA/CC

Corriente nominal de operación $I_e$ AC-3 ( $U_e \leq 440$ V)	Corriente térmica convencional $I_m = I_e$ AC-1	Potencia nominal máxima de operación motores trifásicos 50/60 Hz <sup>1)</sup>					Contactos auxiliares integrados en el contactor (BCXML)		Referencia para completar con el código de tensión de mando	Peso kg
		220 V 230 V	380 V 400 V	415 V 440 V	500 V	660 V 690 V	*3   *4	L*1 *2		
A	A	(kW / HP)	(kW / HP)	(kW / HP)	(kW / HP)	(kW / HP)	NA	NC		
112	180	30 / 40	55 / 75	55 / 75	55 / 75	75 / 100	2	2	CWM112-22-30♦	3,12
150	225	45 / 60	75 / 100	90 / 125	90 / 125	110 / 150	2	2	CWM150-22-30♦	3,20
180	225	55 / 75	90 / 125	110 / 150	110 / 150	110 / 150	2	2	CWM180-22-30♦	5,01
215	315	55 / 75	110 / 150	132 / 175	150 / 200	150 / 200	2	2	CWM215-22-30♦	5,01
250	350	75 / 100	132 / 175	150 / 200	150 / 200	150 / 200	2	2	CWM250-22-30♦	6,86
300	410	95 / 125	150 / 200	185 / 250	185 / 250	185 / 250	2	2	CWM300-22-30♦	6,73

Reemplazar "♦" con el código de tensión deseado<sup>2)</sup>.

Códigos de tensión de bobinas	E02	E06	E07	E10	E13	E16	E21
50/60 Hz / DC <sup>3)</sup>	24-28 V	42-50 V	60-72 V	110-130 V	208-250 V	360-415 V	430-500 V



### Contadores Tripolares de 400 hasta 800 A (AC-3) - Bobina con Módulo Electrónico CA/CC

Corriente nominal de operación $I_e$ AC-3 ( $U_e \leq 440$ V)	Corriente térmica convencional $I_m = I_e$ AC-1	Potencia nominal máxima de operación motores trifásicos 50/60 Hz <sup>1)</sup>					Contactos auxiliares integrados en el contactor (BCXML)		Referencia para completar con el código de tensión de mando	Peso kg
		220 V 230 V	380 V 400 V	415 V 440 V	500 V	660 V 690 V	*3   *4	L*1 *2		
A	A	(kW / HP)	(kW / HP)	(kW / HP)	(kW / HP)	(kW / HP)	NA	NC		
400	450	110 / 150	220 / 300	220 / 300	260 / 350	260 / 350	2	2	CWM400-22-30♦	9,2
450	600	150 / 200	260 / 350	260 / 350	260 / 350	300 / 400	2	2	CWM450-22-30♦	11,7
500	580	150 / 200	260 / 350	260 / 350	300 / 400	330 / 450	2	2	CWM500-22-30♦	22,4
560	700	185 / 250	300 / 400	300 / 400	330 / 450	370 / 500	2	2	CWM560-22-30♦	11,7
630	660	200 / 270	330 / 450	330 / 450	330 / 450	400 / 550	2	2	CWM630-22-30♦	23,2
800	900	220 / 300	440 / 600	440 / 600	515 / 700	515 / 700	2	2	CWM800-22-30♦	23,3

Reemplazar "♦" con el código de tensión deseado<sup>2)</sup>.

Código	E35	E36	E39	E65	D80	D81	D82
Modelos	100...127 V 50/60 Hz 100...110 V cc	100...240 V 50/60 Hz 100...220 V cc	200...240 V 50/60 Hz 200...220 V cc	110...255 V 50/60 Hz 110...255 V cc	265...347 V 50/60 Hz	380...450 V 50/60 Hz	440...575 V 50/60 Hz
CWM400	-	Disponible	-	-	Disponible	Disponible	Disponible
CWM450 CWM560	-	-	-	Disponible	-	-	-
CWM500 CWM630 CWM800	Disponible	-	Disponible	-	Disponible	Disponible	Disponible

Notas: 1) Los dimensionamientos presentados son válidos para motores WEG W22 Plus, IV polos, factor de servicio 1,0 y categoría de servicio AC-3.

Estos valores son orientativos y pueden cambiar de acuerdo con el número de polos o proyecto del motor.

2) Otras tensiones bajo consulta.

3) Supresor de surto ya está integrado.

## Contadores CWM - Tabla de Selección



### Contadores Tetrapolares de 25 hasta 32 A (AC-1)

$I_e = I_n$ $(U_e \leq 690 V)$ $\theta \leq 55^\circ C$ AC-1 A	Numero de polos		Referencia para completar con el código de tensión de mando	Peso kg
	3   4   NA	1   2   NC		
25	2	2	CWM9-00-22 ♦	0,360
	4	-	CWM9-00-40 ♦	
25	2	2	CWM12-00-22 ♦	0,360
	4	-	CWM12-00-40 ♦	
32	2	2	CWM18-00-22 ♦	0,360
	4	-	CWM18-00-40 ♦	

Reemplazar "♦" con el código de tensión deseado<sup>1)</sup>.

Bobina CA - 50/60 Hz											
Códigos de tensión de bobinas	D02	D07	D13	D23	D24	D25	D33	D34	D35	D36	D39
V ca - 50/60 Hz	24	48	110	220	230	240	380	400	415	440	480

### Contadores Tetrapolares de 520 hasta 1.050 A (AC-1)

Corriente térmica convencional $I_n$ (40 °C) A	Corriente AC-1 A	Potencia AC-1						Contactos auxiliares integrados por contactor (BCXML)		Referencia para completar con el código de tensión de mando	Peso kg
		220 V 240 V kW	380 V 400 V kW	415 V 440 V kW	500 V kW	575 V 600 V kW	660 V 690 V kW	3   4   NA	1   2   NC		
520		198	342	374	450	518	594	2	2	CWM400-22-40 ♦	9,9
700		267	461	503	606	697	800	2	2	CWM500-22-40 ♦	26,3
900		343	592	647	779	896	1.029	2	2	CWM630-22-40 ♦	26,3
1.050		400	691	755	909	1.046	1.200	2	2	CWM800-22-40 ♦	26,3

Reemplazar "♦" con el código de tensión deseado<sup>1)</sup>.

Códigos de tensión de bobinas (CWM400)	E36	D81
50/60 Hz / CC <sup>2)</sup>	100-240 V ca / 100-220 V cc	-
50/60 Hz <sup>2)</sup>	-	380-450 V



Códigos de tensión de bobinas (CWM500/630/800)	E35	E39
50/60 Hz / CC <sup>2)</sup>	100-127 V ca / 100-110 V cc	200-240 V ca / 200-220 V cc

Notas: 1) Otras tensiones bajo consulta.  
2) Supresor de surto ya está integrado.

## Contadores CWM - Accesorios

### Bloques de Contactos Auxiliares

- Contactos positivamente guiados de acuerdo con IEC/EN 60947-4-1 y IEC/EN 60947-5-1
- Marcación de los terminales: EN 50 005 y EN 50 012

Foto ilustrativa	Para uso con	Num. máx. de contactos adicionales / contactor	Contactos auxiliares		Marcación de terminales	Referencia	Peso kg	
			NA	NC				
	CWM9...105	4 / CWM9...25 6 / CWM32...40	1	0	-3	BCXMF10	0,015	
			1	0	-4	BCXMF10-AU <sup>4)</sup>		
			0	1	-1	BCXMF01		
			0	1	-2	BCXMF01-AU <sup>4)</sup>		
			1 <sup>1)</sup>	0	-7	BCXMF10		
			0	1 <sup>2)</sup>	-5	BCXMF01		
	CWM9...300	8 / CWM50...105 8 / CWM112...300	2	0	13 14 23 24 33 34	BCXML20	0,050	
			1	1	13 14 21 22 31 32	BCXML11		
			2	0	53 54 63 64 73 74	BCXMRL20 <sup>3)</sup>		
			1	1	53 54 61 62 71 72	BCXMRL11 <sup>3)</sup>		
	CWM400 CWM500 CWM630 CWM800	8 / CWM400 8 / CWM500 8 / CWM630 8 / CWM800	1	1	13 14 21 22 31 32	BCXML11 CWM800	0,045	
					53 54 61 62 71 72	BCXML11 CWM800 <sup>3)</sup>		
		CWM450 CWM560	8 / CWM450 8 / CWM560	1	1	101 102 111 112 121 122	BLB-11	0,034
				2	0	93 94 103 104 113 114 123 124	BLB-20	
0				2	101 102 111 112 121 122	BLB-02		
1				1	133 134 141 142 151 152 161 162	BLRB-11 <sup>3)</sup>		
2				0	133 134 143 144 151 152 161 162	BLRB-20 <sup>3)</sup>		
0				2	131 132 141 142 151 152 161 162	BLRB-02 <sup>3)</sup>		
132 133 141 142 151 152 161 162								

Notas: 1) Contacto abierto adelantado.

2) Contacto cerrado retrasado.

3) Para combinaciones de dos bloques de contactos auxiliares laterales en el mismo lado del contactor.

4) Bloque de contacto especial para corriente muy baja (1 mA / 17 V).

## Contadores CWM - Accesorios

### Enclavamiento Mecánico para Contactores<sup>1)</sup>

Foto ilustrativa	Para uso con	Referencia	Peso kg
	CWM9...CWM105	BLIM9-105	0,050
		BLIM.02 <sup>2)</sup>	
	CWM112...CWM300 CWM450 / CWM560	BLIM112-300	0,150
	CWM400	BLIM CWM400	0,100
	CWM500 / CWM630 / CWM800 - 3 poles	BLIM CWM800	15,0
	CWM500 / CWM630 / CWM800 - 4 poles	BLIM CWM800-4P	16,0

### Supresores de Surto

- Conexión directa en los terminales A1 y A2 de la bobina

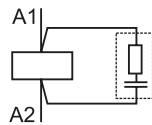

Foto ilustrativa	Para uso con	Tensión	Diagrama	Referencia	Peso kg
	CWM9...40	24 - 48 V 50/60 Hz		BAMRC4 D53	0,014
		50 - 127 V 50/60 Hz		BAMRC5 D55	
		130 - 250 V 50/60 Hz		BAMRC6 D63	
	CWM50...105	24 - 48 V 50/60 Hz		BAMRC7 D53	
		50 - 127 V 50/60 Hz		BAMRC8 D55	
		130 - 250 V 50/60 Hz		BAMRC9 D63	
	CWM112...250	24 - 48 V 50/60 Hz		BAMRC13 D53	
		50 - 250 V 50/60 Hz		BAMRC14 D56	
	CWM9...105	270 - 380 V 50/60 Hz		BAMV1 D68	
		400 - 510 V 50/60 Hz		BAMV2 D73	
	CWM112...250	270 - 380 V 50/60 Hz		BAMV3 D68	
		400 - 510 V 50/60 Hz		BAMV4 D73	

Notas: 1) Aplicable solamente para contactores de mismo tamaño.  
2) Accesorio permite enclavamiento eléctrico y mecánico.

## Contactores CWM - Accesorios

### Cubrebornes

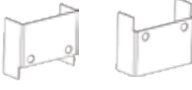
■ Protección contra contactos de acuerdo con reglas de seguridad

Foto ilustrativa	Para uso con	Descripción	Referencia	Peso kg
	CWM112/150	1 kit con 2 piezas <sup>1)</sup>	BMP CWM150	0,10
	CWM180/215		BMP CWM180	0,15
	CWM250/300		BMP CWM300	0,20
	CWM450/560		BMP CWM560	0,220
	CWM112/150	1 kit con 1 pieza <sup>1)</sup>	BMP1 CWM150	0,05
	CWM180/215		BMP1 CWM180	0,08
	CWM250/300		BMP1 CWM300	0,10
	CWM450/560		BMP1 CWM560	0,110
	CWM400 (3 polos)	1 kit con 2 piezas <sup>1)</sup>	BMP CWM400	0,12
	CWM500 / CWM630 / CWM800 (3 polos)		BMP CWM800	0,28
	CWM400 (4 polos)		BMP CWM400-4P	0,16
	CWM500 / CWM630 / CWM800 (4 polos)		BMP CWM800-4P	0,37

### Bloque de Prensacables<sup>2)</sup>

Foto ilustrativa	Para uso con	Cables flexibles	Par de apriete	Descripción	Referencia	Peso kg
	CWM112/150	25...70 mm <sup>2</sup> 3...2/0 AWG	14 N.m	1 pieza de 3 polos	TB150	0,29
	CWM180/215	50...120 mm <sup>2</sup> 1/0...250 kcmil AWG	14 N.m		TB180	0,35
	CWM250/300	50...150 mm <sup>2</sup> 1/0...300 kcmil AWG	20 N.m		TB300	0,45

### Prensacables

Foto ilustrativa	Para uso con	Descripción	Referencia	Peso kg
	CWM400 - Tripolares	1 kit con 3 piezas Cables: 2 x 3...4/0 AWG	BMJ CWM400	0,495
	CWM500 / CWM630 / CWM800 - Tripolares	1 kit con 3 piezas Cables: 2 x 3/0 AWG ... 600 Kcmil	BMJ CWM400	1,0

Notas: 1) Cada pieza hace la protección de 3 terminales.

2) Grado de protección IP20 para contactos frontales.



## Contadores CWM - Accesorios

### Barras para Arranque Reverso<sup>1)</sup>

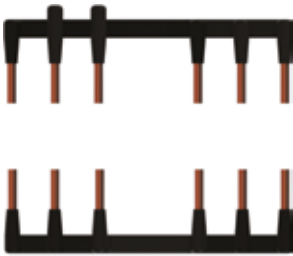
Foto ilustrativa	Corriente nominal de operación le AC - 3 (U <sub>e</sub> ≤ 440 V) A	Potencia nominal de operación máx. motores trifásicos 50/60 Hz			Contadores		Referencia	Peso kg
		220-230 V	400-415 V	660-690 V	K1 = K2			
		kW / HP	kW / HP	kW / HP				
	9	2,2 / 3	4 / 5	5,5 / 7,5	CWM9		EC-R-7,5	0,033
	12	3 / 4	5,5 / 7,5	7,5 / 10	CWM12			
	18	4,5 / 6	7,5 / 10	11 / 15	CWM18			
	25	5,5 / 7,5	11 / 15	11 / 15	CWM25		EC-RC-11	0,5
	32	9,2 / 12,5	15 / 20	18,5 / 25	CWM32		EC-RC-18,5	
	40	11 / 15	18,5 / 25	22 / 30	CWM40			
	50	15 / 20	22 / 30	30 / 40	CWM50		EC-RC-37	
	65	18,5 / 25	30 / 40	37 / 50	CWM65			
80	22 / 30	45 / 60	45 / 60	CWM80				

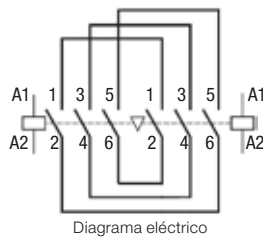
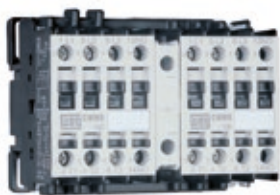

### Barras para Arranque Estrella-Triángulo<sup>1)</sup>

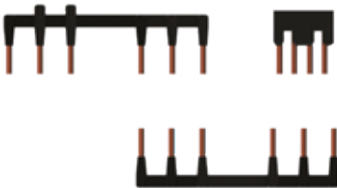
Foto ilustrativa	Corriente nominal de operación le AC - 3 (U <sub>e</sub> ≤ 440 V) A	Potencia nominal de operación máx. motores trifásicos 50/60 Hz			Contadores		Referencia	Peso kg
		220-230 V	400-415 V	660-690 V	K1 = K2	K3		
		kW / HP	kW / HP	kW / HP				
	25	5,5 / 7,5	11 / 15	18,5 / 25	CWM18	CWM9	EC-SD-15	0,051
	32	7,5 / 10	15 / 20	18,5 / 25	CWM18	CWM12		
	40	7,5 / 10	18,5 / 25	22 / 30	CWM25	CWM18	EC-SD-22	0,5
	50	11 / 15	22 / 30	22 / 30	CWM25	CWM18		
	54	15 / 20	22 / 30	30 / 40	CWM32	CWM18	EC-SD-25	
	60	15 / 20	30 / 40	37 / 50	CWM40	CWM25	EC-SD-30	
	80	18,5 / 25	37 / 50	45 / 60	CWM50	CWM25	EC-SD-37	
	85	22 / 30	45 / 60	55 / 75	CWM50	CWM32	EC-SD-55	
	105	30 / 40	55 / 75	55 / 75	CWM65	CWM40		
	138	37 / 50	75 / 100	75 / 100	CWM80	CWM50	EC-SD-75	
	140	37 / 50	75 / 100	90 / 125	CWM95	CWM50	EC-SD-90	
	175	45 / 60	90 / 125	110 / 150	CWM105	CWM65		

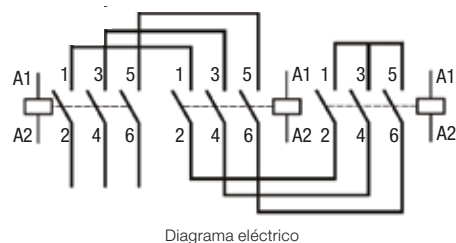
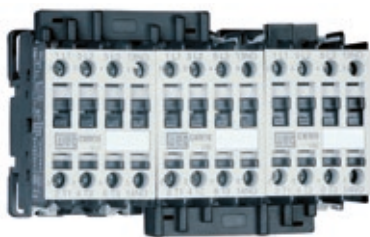

### Barra Tripolar (k3) para Arranadores Estrella-Triángulo

Foto ilustrativa	Para usar con	Description	Referencia	Peso kg
	CWM9...18	Barra tripolar para conectar en paralelo bornes L1-L2-L3 de contactor K3 en un arranque estrella-triángulo	SBCM9-18	0,006
	CWM25		SBCM25	0,006
	CWM32/40		SBCM32-40	0,015
	CWM50/65		SBCM50-65	0,031

Nota: 1) Contactores y enclavamiento mecánico se venden por separado.

# Contadores CWM - Accesorios

## Componentes Individuales para Arrancadores Reversibles

Potencia nominal de operación máx. motores trifásicos 50/60 Hz				Componentes individuales para arranque reverso					
220-230 V (kW / HP)	400-415 V (kW / HP)	500 V (kW / HP)	660-690 V (kW / HP)	Contactor	Contactor	Contactos auxiliares		Enclavamiento mecánico	Kit de barras
				K1	K2	K1	K2		
				Tipo	Tipo				
2,2 / 3	4 / 5	4,5 / 6	5,5 / 7,5	CWM9-11	CWM9-11	-	-	BLIM9-105	EC-SD...
3 / 4	5,5 / 7,5	5,5 / 7,5	7,5 / 10	CWM12-11	CWM12-11	-	-		
4,5 / 6	7,5 / 10	9,2 / 12,5	11 / 15	CWM18-11	CWM18-11	-	-		
5,5 / 7,5	11 / 15	11 / 15	11 / 15	CWM25-11	CWM25-11	-	-		
9,2 / 12,5	15 / 20	15 / 20	18,5 / 25	CWM32-11	CWM32-11	-	-		
11 / 15	18,5 / 25	22 / 30	22 / 30	CWM40-11	CWM40-11	-	-		
15 / 20	22 / 30	30 / 40	30 / 40	CWM50-11	CWM50-11	-	-		
18,5 / 25	30 / 40	37 / 50	37 / 50	CWM65-11	CWM65-11	-	-		
22 / 30	45 / 60	45 / 60	45 / 60	CWM80-11	CWM80-11	-	-		
22 / 30	55 / 75	55 / 75	55 / 75	CWM95-11	CWM95-11	-	-		
30 / 40	55 / 75	55 / 75	55 / 75	CWM105-11	CWM105-11	-	-	BLIM112-300	-
30 / 40	55 / 75	55 / 75	75 / 100	CWM112-22	CWM112-22	1NA/1NC	1NA/1NC		
45 / 60	75 / 100	90 / 125	110 / 150	CWM150-22	CWM150-22	1NA/1NC	1NA/1NC		
55 / 75	90 / 125	110 / 150	110 / 150	CWM180-22	CWM180-22	1NA/1NC	1NA/1NC		
75 / 100	132 / 175	160 / 220	160 / 220	CWM250-22	CWM250-22	1NA/1NC	1NA/1NC		
90 / 125	160 / 220	200 / 270	200 / 270	CWM300-22	CWM300-22	1NA/1NC	1NA/1NC		

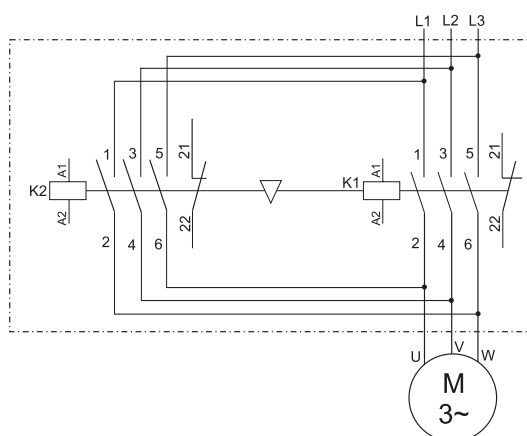
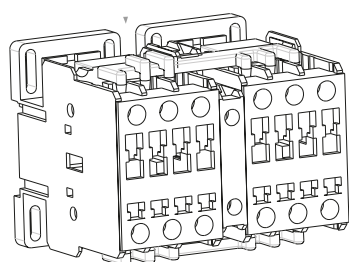

Arranques reversos

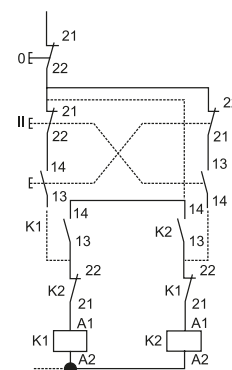

# Contadores CWM - Accesorios

## Componentes Individuales para Arrancadores Estrella-Triángulo

Potencia máxima nominal de operación motores trifásicos 50/60 Hz				Componentes individuales para arrancadores estrella-triángulo							
220-230 V (kW / HP)	400-415 V (kW / HP)	500 V (kW / HP)	660-690 V (kW / HP)	Contactor principal K1	Contactor triángulo K2	Contactor estrella K3	Temporizador	Contactos auxiliares			Kit de barras
				Referencia	Referencia	Referencia		K1	K2	K3	
5,5 / 7,5	11 / 15	15 / 20	18,5 / 25	CWM18-10 + BCXMF10	CWM18-11	CWM9-11	RTW-ET...	-	-	-	EC-SD...
7,5 / 10	15 / 20	15 / 20	18,5 / 25	CWM18-10 + BCXMF10	CWM18-11	CWM12-11		-	-	-	
7,5 / 10	18,5 / 25	22 / 30	22 / 30	CWM25-00 + 2 x BCXMF10	CWM25-11	CWM18-11		-	-	-	
11 / 15	22 / 30	22 / 30	22 / 30	CWM25-00 + 2 x BCXMF10	CWM25-11	CWM18-11		-	-	-	
15 / 20	30 / 40	37 / 50	37 / 50	CWM40-00 + 2 x BCXMF10	CWM40-11	CWM25-11		-	-	-	
18,5 / 25	37 / 50	37 / 50	45 / 60	CWM50-00 + 2 x BCXMF10	CWM50-11	CWM25-11		-	-	-	
22 / 30	45 / 60	45 / 60	55 / 75	CWM50-00 + 2 x BCXMF10	CWM50-11	CWM32-11		-	-	-	
30 / 40	55 / 75	55 / 75	55 / 75	CWM65-00 + 2 x BCXMF10	CWM65-11	CWM40-11		-	-	-	
37 / 50	75 / 100	75 / 100	90 / 125	CWM95-00 + 2 x BCXMF10	CWM95-11	CWM50-11		-	-	-	
45 / 60	90 / 125	110 / 150	110 / 150	CWM105-00 + 2 x BCXMF10	CWM105-11	CWM65-11		-	-	-	
55 / 75	110 / 150	110 / 150	132 / 175	CWM150-22	CWM150-22	CWM65-11		2NC	1NA/NC	-	
75 / 100	132 / 175	132 / 175	132 / 175	CWM180-22	CWM180-22	CWM80-11		2NC	1NA/NC	-	
90 / 125	160 / 220	160 / 220	200 / 300	CWM250-22	CWM250-22	CWM105-11		2NC	1NA/NC	-	
110 / 150	200 / 270	250 / 330	-	CWM300-22	CWM300-22	CWM150-22		2NC	1NA/NC	1NA/NC	

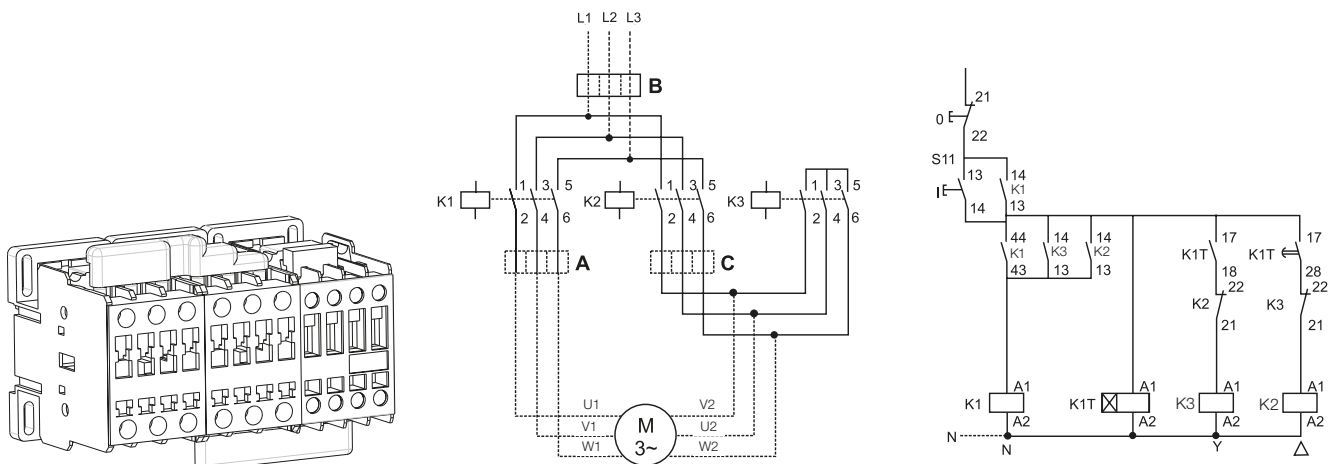

A:  $0,58 \times I_r$ , protección del motor en la posición estrella y triángulo  
 B:  $1 \times I_r$ , solamente protección parcial del motor en la posición estrella  
 C:  $0,58 \times I_r$ , motor no protegido en la posición estrella

## Contadores CWM - Repuesto

### Bobinas Individuales

Foto ilustrativa	Descripción	Para uso con	Referencia	Peso kg
	Bobina CA	CWM9...25	BCA4-25♦	0,065
		CWM32/40	BCA4-40♦	0,110
		CWM50...105	BCA-105♦	0,140
		CWM112	BCA-112♦	0,235
		CWM180	BCA-180♦	0,400
		CWM250	BCA-250♦	0,675
	Bobina CC	CWM40	BECC4-40♦	0,180
		CWM50...105	BECC-105♦	0,220
	Bobina doble tensión CA/CC (contactores con módulo electrónico)	CWM112/150	BCE-150♦	0,235
		CWM180/215	BCE-215♦	0,400
		CWM250/300	BCE-300♦	0,675
		CWM400	BCE400♦ <sup>1)</sup>	1,130
CWM450 / CWM560		BCE560♦	1,308	
CWM500 / CWM630 / CWM800	BCE800♦ <sup>1)</sup>	2,350		

### Módulo Electrónico

Foto ilustrativa	Tipo controle	Para uso con	Referencia	Peso kg
	CA/CC	CWM112...300	ME-300♦ <sup>3)</sup>	0,140
		CWM450 / CWM560	ME560♦ <sup>3)</sup>	0,086

Reemplazar “♦” con el código de tensión deseado<sup>2)</sup>.

### Contadores CWM9...300

Códigos de tensión de bobinas (CWM9...250)	D02	D07	D13	D24	D25	D34	D35
50/60 Hz	24 V	48 V	110 V	230 V	240 V	400 V	415 V

Códigos de tensión de bobinas (CWM40...105)	C34	C37	C40	C44
V cc	24-28 V	42-50 V	110-130 V	208-240 V

Códigos de tensión de bobinas (CWM112...300)	E02	E06	E07	E10	E13	E16	E21
50/60 Hz / CC <sup>4)</sup>	24-28 V	42-50 V	60-72 V	110-130 V	208-250 V	360-415 V	430-500 V

### Contadores CWM400...800

Código	E35	E36	E39	E65	D80	D81	D82
Modelos	100...127 V 50/60 Hz 100...110 V cc	100...240 V 50/60 Hz 100...220 V cc	200...240 V 50/60 Hz 200...220 V cc	110...255 V 50/60 Hz 110...255 V cc	265...347 V 50/60 Hz	380...450 V 50/60 Hz	440...575 V 50/60 Hz
CWM400	-	Disponible	-	-	Disponible	Disponible	Disponible
CWM450 CWM560	-	-	-	Disponible	-	-	-
CWM500 CWM630 CWM800	Disponible	-	Disponible	-	Disponible	Disponible	Disponible

Notas: 1) Bobina integrada con módulo electrónico.

2) Otras tensiones bajo consulta.

3) El código de la tensión del módulo electrónico debe ser el mismo código de la bobina BCE elegida.

4) Supresor de surto ya está integrado.

## Contadores CWM - Características Técnicas

### Datos Generales

Referencia	CWM	9	12	18	25	32	40	50	65	80	95	105	112	150	180	250	300	
Normas		IEC/EN 60 947, UL											IEC/EN 60 947					
Tensión nominal de aislamiento $U_i$ IEC/EN 60 947 UL		1.000 V 600 V																
Tensión soportados a los impulsos $U_{imp}$		6 kV								8 kV								
Frecuencia nominal de operación		25 - 400 Hz																
Grado de protección Circuitos principales Circuitos de control y contactos auxiliares		Protección contra contacto directo frontal cuando actuado por un dedo de ensayo perpendicular (IEC 536)																
		IP20				IP10								IP00				
		IP20																
Temperatura ambiente Temperatura de operación Temperatura de almacenado		-25 °C to +55 °C -55 °C to +80 °C																
Altitud Valores normales 90% $I_g$ / 80% $U_g$ 80% $I_g$ / 75% $U_g$		Hasta 3.000 m 3.000 hasta 4.000 m 4.000 hasta 5.000 m																
Categoría de sobretensión / grado de polución		III / 3																
Protección a la intemperie		Acc. IEC 60680-2																
Numero de polos de los circuitos principales		3																
Tensión nominal de operación $U_g$		690 V								1.000 V								
Vida mecánica	Ops x 10 <sup>6</sup>	10																
Vida eléctrica (AC - 3)	Ops x 10 <sup>6</sup>	1,5	1,2				1,1					1,0						
Montaje		Tornillo o riel DIN 35 mm (DIN EN 50022)													Tornillo			

### Circuito de Control

Referencia	CWM	9	12	18	25	32	40	50	65	80	95	105	112	150	180	215	250	300		
Tensión nominal de aislamiento $U_i$	IEC/EN UL	1.000 V 600 V																		
Tensiones nominales (bobina estándar)	Us 50/60 Hz	12...660 V										24...550 V	-	24...600 V	-	24...600 V	-			
Tensiones nominales (bobina con módulo electrónico)	Us 50/60 Hz	-										24...500 V								
Tensiones nominales	Us CC	-				24...240 V								24...500 V						
Tiempo de operación <sup>1)</sup>	Cerrando/apertura (CA) ms	8...20 / 6...13				10...19 / 5...25		15...30 / 9...15					60...70 / 13...17							
	Cerrando/apertura (CC) ms	-				50...60 / 55...60					60...70 / 13...17				60...70 / 15...25					
Consumo de la bobina CA, 50/60 Hz <sup>1)</sup>																				
Cerrando	(VA)	69,5				98		255					590			759		1.104		
	cos φ	0,85				0,69		0,32					0,43			0,14		0,16		
Régimen	(VA)	4...7,2				6,6...12,3		13,1...19,1					28...41			37...52		70...105		
	cos φ	0,28				0,34		0,54					0,31			0,39		0,36		
Límites de operación de la bobina 50/60 Hz <sup>1)</sup>		0,85...1,1 x $U_g$										0,85...1,1 x $U_g$								
Bobinas doble frecuencia <sup>1)</sup>	Cerrando	0,5...0,8				0,5...0,8		0,5...0,8					0,7...0,85			0,7...0,85		0,7...0,85		
	Régimen	0,2...0,6				0,2...0,6		0,25...0,6					0,4...0,6			0,4...0,6		0,4...0,6		
Consumo de la bobina, bobinas CC																				
Cerrando	(W)	-				240		340					415			375		380		
Régimen	(W)	-				6		6,5					12,5			12,5		12,5		
Numero de terminales	Bobina CA	4				4		3					2							
	Bobina CC	-				4		3					2							

Nota: 1) Valores aplicados para contactores CWM112...300 con módulo electrónico. Informaciones para contactores con bobina estándar solamente bajo consulta.

# Contadores CWM - Características Técnicas

## Contactos Principales

Referencia	CWM9	CWM12	CWM18	CWM25	CWM32	CWM40	CWM50	CWM65	CWM80	CWM95	CWM105	CWM112	CWM150	CWM180	CWM215	CWM250	CWM300		
Corriente nominal de operación $I_n$	AC-3 ( $U_n \leq 440$ V) (A)	9	12	18	25	32	40	50	65	80	95	105	112	150	180	215	250	300	
	AC-4 ( $U_n \leq 440$ V) (A)	5	7	8	12	16	18,5	23	30	37	44	50	61	66	74	90	104	132	
	AC-1 ( $\theta \leq 55$ °C, $U_n \leq 690$ V) (A)	25	25	32	45	60	60	90	110	110	140	140	180	225	225	315	350	410	
Tensión nominal de operación $U_n$	IEC/EN 60947-4-1 (V)	690						600						1.000					
	UL (V)																		
Corriente térmica convencional $I_{th}$ ( $\theta \leq 55$ °C)	(A)	25	25	32	45	60	60	90	110	110	140	140	180	225	225	315	350	410	
Capacidad de conexión - IEC/EN 60947	(A)	300	300	300	450	550	550	1.000	1.000	1.000	1.280	1.280	1.430	1.820	2.100	2.550	2.600	3.000	
Capacidad de desconexión	( $U_n \leq 400$ V) (A)	250	250	250	350	450	450	920	920	920	1.050	1.050	1.290	1.350	1.400	1.990	2.000	2.400	
	( $U_n = 500$ V) (A)	250	250	250	320	450	450	920	920	920	1.050	1.050	1.290	1.350	1.400	1.990	2.000	2.400	
	( $U_n = 690$ V) (A)	130	130	130	170	205	205	780	780	780	950	950	-	-	-	-	-	-	
Corriente de corta duración sin corriente durante el tiempo de enfriamiento de 10min y $\theta \leq 40$ °C)	1s (A)	455	455	570	630	1.010	1.265	1.580	2.530	2.530	3.300	3.300	3.165	3.763	4.649	4.870	5.090	5.534	
	5s (A)	205	205	254	280	450	450	710	1.130	1.130	1.485	1.485	1.820	2.164	2.673	2.800	2.927	3.182	
	10s (A)	144	144	180	200	320	400	500	800	800	1.050	1.050	1.430	1.700	2.100	2.200	2.300	2.500	
	30s (A)	85	85	104	115	185	230	290	460	460	600	600	950	1.127	1.394	1.460	1.527	1.660	
	1min (A)	60	60	74	80	130	165	205	325	325	430	430	701	833	1.028	1.078	1.127	1.225	
	3min (A)	35	35	46	50	90	100	120	185	185	250	250	438	521	643	674	705	766	
Protección contra cortocircuitos con fusibles (gL/gG)	@ 600 V - UL (kA)	5						10						18					
	Coordination type 1 (A)	50	50	63	63	100	125	200	200	200	250	250	-	355	355	-	500	630	
	Coordination type 2 (A)	25	35	35	50	63	80	100	125	125	160	200	224	250	250	-	400	500	
Impedancia por polo	(mΩ)	2,4	2,4	2,4	1,7	1,3	1,0	0,9	0,9	0,9	0,8	0,8	0,5	0,5	0,45	0,45	0,3	0,3	
Disipación de potencia por polo	AC-1 (W)	1,5	1,5	2,5	3,3	4,6	3,4	6,7	10,4	10,4	14,9	14,9	16	25	21,6	38,4	35	45,7	
	AC-3 (W)	0,2	0,3	0,8	1,0	1,3	1,5	2,1	3,6	5,5	6,9	8,4	6,2	11,1	13,8	19,7	17,9	25,7	
<b>Categoría de servicio AC-3</b>																			
Corriente nominal de operación $I_n$ ( $\theta \leq 55$ °C)	$U_n \leq 440$ V (A)	9	12	18	25	32	40	50	65	80	95	105	112	150	180	215	250	300	
	$U_n \leq 500$ V (A)	7,5	10,5	14	19	24	32	38	55	63	79	85	95	130	155	190	220	265	
	$U_n \leq 690$ V (A)	7	9	13	15	22	25	34	44	48	60	67	82	110	135	160	185	220	
	$U_n \leq 1.000$ V (A)	No disponible						19	25	30	37	40	42	48	68	82	103	126	
Potencia nominal de operación	220 / 230 V	(kW)	2,2	3	4,5	5,5	9,2	11	15	18,5	22	22	30	30	45	55	75	90	
		(HP)	3	4	6	7,5	12,5	15	20	25	30	30	40	40	60	75	100	125	
	380 / V	(kW)	3,7	5,5	7,5	11	15	18,5	22	30	37	45	55	55	75	90	110	132	150
		(HP)	5	7,5	10	15	20	25	30	40	50	60	75	75	100	125	150	175	200
	400 / 415 V	(kW)	3,7	5,5	7,5	11	15	18,5	22	30	37	45	55	55	75	110	132	132	150
		(HP)	5	7,5	10	15	20	25	30	40	50	60	75	75	100	150	175	175	200
	440 V	(kW)	4,5	5,5	9,2	11	15	22	30	37	45	55	55	55	90	110	150	150	185
		(HP)	6	7,5	12,5	15	20	30	40	50	60	75	75	75	125	150	200	200	250
	500 V	(kW)	4,5	5,5	9,2	11	15	22	30	37	45	55	55	55	90	110	150	150	185
		(HP)	6	7,5	12,5	15	20	30	40	50	60	75	75	75	125	150	200	200	250
	660 / 690 V	(kW)	5,5	7,5	11	11	18,5	22	30	37	45	55	55	75	110	110	90	150	185
		(HP)	7,5	10	15	15	25	30	40	50	60	75	75	100	150	150	125	200	250
Porcentaje de la corriente máxima de operación en	600 ops./h (%)	100	100	100	100	100	100	100	100	100	100	100	100	100	100	100	100	100	
	1.200 ops./h (%)	100	100	100	100	100	100	100	100	100	75	75	75	75	75	75	75	75	
	3.000 ops./h (%)	35	35	35	35	35	35	35	35	35	25	25	25	25	25	25	25	25	
<b>Categoría de servicio AC-4</b>																			
Corriente nominal de operación $I_n$ AC-4 ( $U_n \leq 690$ V)	(A)	4	5	6	8	12	14	16	21	27	32	35	48	53	58	90	88	116	
Potencia nominal de operación	220 / 230 V	(kW)	1,1	1,5	1,5	3	3,7	4,5	5,5	7,5	9,2	11	11	18,5	18,5	22	80	37	45
		(HP)	1,5	2	2	4	5	6	7,5	10	12,5	15	15	25	25	30	79	50	60
	380 / 400 V	(kW)	2,2	3	3,7	5,5	7,5	9,2	11	15	18,5	22	25	30	30	37	25	55	75
		(HP)	3	4	5	7,5	10	12,5	15	20	25	30	33	40	40	50	34	75	100
	415 V	(kW)	2,2	3,7	4,5	5,5	9,2	11	11	15	18,5	22	25	37	37	45	45	55	75
		(HP)	3	5	6	7,5	12,5	15	15	20	25	30	33	50	50	60	60	75	100
	440 V	(kW)	2,2	3,7	4,5	5,5	9,2	11	15	15	22	22	30	37	37	45	55	55	75
		(HP)	3	5	6	7,5	12,5	15	20	20	30	30	40	50	50	60	75	75	100
	500 V	(kW)	3	3,7	5,5	7,5	9,2	11	15	18,5	22	22	30	37	45	45	63	75	90
		(HP)	4	5	7,5	10	12,5	15	20	25	30	30	40	50	60	60	84	100	125
	660 / 690 V	(kW)	3	4,5	5,5	7,5	11	11	15	18,5	22	30	30	45	45	55	75	90	90
		(HP)	4	6	7,5	10	15	15	20	25	30	40	40	60	60	75	100	125	125

# Contadores CWM - Características Técnicas

## Contactos Principales

Referencia		CWM9	CWM12	CWM18	CWM25	CWM32	CWM40	CWM50	CWM65	CWM80	CWM95	CWM105	CWM112	CWM150	CWM180	CWM215	CWM250	CWM300	
Categoría de servicio AC-1																			
		3P (NA) o 4P (4NA)				3P (NA)						3P (NA)							
Corriente térmica convencional $I_m$ ( $\theta \leq 55^\circ\text{C}$ )	(A)	25	25	32	45	60	60	90	110	110	140	140	180	225	225	315	350	410	
Corriente máxima de operación a la temperatura ambiente de (hasta 690 V)	$\theta \leq 55^\circ\text{C}$	(A)	25	25	32	45	60	60	90	110	110	140	140	160	190	200	315	350	350
	$\theta \leq 70^\circ\text{C}$	(A)	20	20	25	32	48	48	72	88	88	110	110	120	145	145	315	215	250
	$\theta \leq 75^\circ\text{C}$	(A)	17	17	22	26	42	42	63	77	77	95	95	101	124	120	200	177	206
Potencia nominal máxima $\theta \leq 55^\circ\text{C}$ (resistores trifásicos)	220 / 230 V	(kW)	9,5	9,5	12	17	22,5	22,5	34	42	42	53	53	68	85	85	120	130	156
	380 / 400 V	(kW)	16,5	16,5	21	29,5	39,5	39,5	59	72,5	72,5	92	92	118	145	145	205	230	270
	415 / 440 V	(kW)	19	19	24	34	45,5	45,5	68,5	84	84	106,5	106,5	130	160	160	225	250	295
	500 V	(kW)	21,5	21,5	27,5	39	52	52	77	95	95	121	121	155	190	190	270	300	355
	575 / 600 V	(kW)	24,1	24,1	30,9	43,4	57,9	57,9	86,8	106,1	106,1	135,1	135,1	180	225	225	310	350	400
660 / 690 V	(kW)	28,5	28,5	38	51	68,5	68,5	100	125	125	160	160	205	255	255	350	400	470	
Sección del cable	(mm <sup>2</sup> )	4	4	6	10	16	16	35	35	35	50	50	120	120	120	185	185	2 x 150	
Valores de corriente para conexión de	2 polos en paralelo	$I_b \times 1,7$																	
	3 polos en paralelo	$I_b \times 2,4$																	
	4 polos en paralelo	$I_b \times 3,2$				-													
Porcentaje de la corriente máxima de operación para	600 ops./h	(%)	100	100	100	100	100	100	100	100	100	100	100	100	100	100	100	100	100
	1.200 ops./h	(%)	100	100	100	100	100	100	100	100	100	80	80	80	80	80	80	80	80
	3.000 ops./h	(%)	50	50	50	50	50	50	50	50	50	40	40	40	40	40	40	40	40
Potencia máxima de operación $\theta \leq 55^\circ\text{C}$ (cargas resistivas)	220 / 230 V	(kW)	5,5	5,5	7,04	9,9	13,2	14,9	22,2	27,5	27,5	34,1	34,1	-	-	-	-	-	
	380 / 400 V	(kW)	9,5	9,5	12,1	17,1	22,8	25,8	38,6	47,5	47,5	58,9	58,9	-	-	-	-	-	
	415 / 440 V	(kW)	10,3	10,3	13,2	18,6	24,9	28,2	42,3	51,8	51,8	64,3	64,3	-	-	-	-	-	
	500 V	(kW)	12,5	12,5	16	22,5	30	34	50,6	62,5	62,5	77,5	77,5	-	-	-	-	-	
	660 / 690 V	(kW)	16,5	16,5	21,1	29,7	39,6	44,8	66	82,5	82,5	102,3	102,3	-	-	-	-	-	

## Parametros de Potencia de Acuerdo con la Norma UL

Referencia			CWM9	CWM12	CWM18	CWM25	CWM32	CWM40	CWM50	CWM65	CWM80	CWM95	CWM105	CWM112	CWM150	CWM180	CWM215	CWM250	CWM300
Corriente de aplicación general	(600 V)	(A)	25	25	32	32	60	60	90	110	110	140	140	170	200	200	250	300	400
1-fase	110 / 120 V	(HP)	0,75	0,75	1	2	3	3	5	5	7,5	7,5	10	-	-	-	-	-	-
	220 / 240 V	(HP)	1,5	2	3	5	5	7,5	10	10	15	15	20	-	-	-	-	-	-
3-fases	200 V	(HP)	3	3	5	7,5	10	10	15	20	20	25	30	40	50	60	60	75	100
	220 / 240 V	(HP)	3	3	5	7,5	10	15	15	20	25	30	40	50	60	75	75	100	125
	440 / 480 V	(HP)	5	7,5	10	15	20	30	40	50	50	60	75	100	125	150	150	200	250
	550 / 600 V	(HP)	7,5	10	15	15	25	25	40	50	60	75	75	100	150	200	200	250	350



## Contadores CWM - Características Técnicas

### Datos Generales y Circuito de Potencia

Referencia	CWM450	CWM560	CWM400	CWM500	CWM630	CWM800
Normas	IEC/EN 60 947		IEC/EN 60 947, UL 508			
Tensión nominal de aislamiento $U_i$ IEC/EN 60 947 UL	1.000 V -		1.000 V 600 V			
Tensión soportada a los impulsos $U_{imp}$	8 kV		6 kV			
Frecuencia nominal de operación	25 - 400 Hz		25 - 400 Hz			
Grado de protección Circuitos principales Circuitos de control y contactos auxiliares			IP00 IP20			
Temperatura ambiente Temperatura de operación Temperatura de almacenado			-25 °C hasta +55 °C -55 °C hasta +80 °C			
Altitude Valores normales 90% $I_e$ / 80% $U_e$ 80% $I_e$ / 75% $U_e$			Hasta 3.000 m 3.000 hasta 4.000 m 4.000 hasta 5.000 m			
Categoría de sobretensión / grado de polución			III / 3			
Protección a la intemperie			Acc. to IEC 60680-2			
Numero de polos de los circuitos principales	3		3 o 4			
Tensión nominal de operación $U_e$ IEC/EN / UL (V)	1.000 / ---		1.000 / 600			
Corriente térmica convencional $I_{th}$ (A)	600	700	520	700	900	1.050
$I_e$ /AC-1 (A)	600	700	520	700	900	1.050
Corriente nominal de operación $I_e$ AC-4 ( $U_e \leq 440$ V) (A)	280	345	300	350	400	630
Categoría de servicio AC-3 Potencia nominal de operación						
220-240 V (kW)	150	185	125	150	190	220
380-400 V (kW)	260	300	220	265	330	440
415-440 V (kW)	260	300	220	265	330	440
500 V (kW)	260	330	225	265	330	500
660-690 V (kW)	300	370	250	300	330	500
Fusible máximo gL-gG (A)	630	800	630	630	800	1.000
Numero máximo de maniobras por hora						
AC-1 Ops/h	150	150	300	300	300	300
AC-3 Ops/h	600	600	1.200	1.200	1.200	1.200
AC-4 Ops/h	75	75	150	150	150	150
Sin carga Ops/h	600	600	1.200	1.200	1.200	1.200
Vida mecánica Ops x 10 <sup>6</sup>	3		5			
Vida eléctrica (AC-3) Ops x 10 <sup>6</sup>			0,5			0,6

### Parametros de Potencia de Acuerdo con la Norma UL

Referencia	CWM450	CWM560	CWM400	CWM500	CWM630	CWM800
Corriente de aplicación general (600 V) (A)	-	-	450	580	660	900
Trifásico	200 V (HP)	-	125	150	200	200
	220 / 240 V (HP)	-	150	200	250	300
	440 / 480 V (HP)	-	300	400	500	600
	550 / 600 V (HP)	-	300	400	500	600

### Circuito de Controle



Referencia (contactores 3 y 4 polos)	CWM450	CWM560	CWM400	CWM500	CWM630	CWM800
Limites de operación de la bobina	0,85...1,1 x $U_e$					
Cerrando (xUs)	0,6...0,75		0,78	0,75		
Apertura (xUs)	0,4...0,6		0,30...0,60		0,30...0,60	
Consumo	Cerrando (VA)	780	571	1.000		
	Cerrado (VA)	38,5	14	29		
	Disipación (W)	10	5	7,8		
Numero de terminales	2					

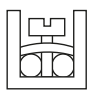

## Contadores CWM - Características Técnicas

### Capacidad de los Terminales e Par de Apriete - Terminales de Potencia

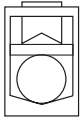
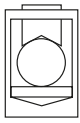
Referencia		CWM9 / CWM12 / CWM18			CWM25		
Tipo de tornillo		M3,5 x 9 Plana / Phillips			M4x 12 Plana / Phillips		
Capacidad de los terminales de potencia <sup>1)</sup>		Cable con terminal	Cable sin terminal	Hilo	Cable con terminal	Cable sin terminal	Hilo
mm <sup>2</sup>		1x 0,5...4 2x 0,5...2,5	1x 1...6 2x 1...2,5 2x 2,5...6	1x 0,5...6 2x 0,5...2,5 2x 2,5...6	1x 1...6 2x 1...2,5 2x 2,5...4	1x 2,5...10 2x 2,5...10	1x 1...10 2x 1...2,5 2x 2,5...10
AWG (UL)		14...10			14...8		
Par de apriete (N.m)		1...1,5			1,6...2,5		
Par de apriete (lb.in) (UL)		15			16		

Referencia		CWM32 / CWM40			CWM50 / CWM65 / CWM80			CWM95 / CWM105		
Tipo de tornillo		M4x 16,5 Plana / Phillips			M8 Allen 4 mm			M10 Allen 4 mm		
Capacidad de los terminales de potencia		Cable con terminal	Cable sin terminal	Hilo	Cable con terminal	Cable sin terminal	Hilo	Cable con terminal	Cable sin terminal	Hilo
Un conductor abajo										
mm <sup>2</sup>		1...16	1,5...16	1...16	2,5...35	6...35	2,5...35	4...35	6...35	4...35
AWG (UL)		14...8			14...1/0			10...1/0		
Un conductor arriba										
mm <sup>2</sup>		0,75...16	1...16	0,75...16	1...35	1,5...35	1...35	1,5...50	2,5...50	1,5...50
AWG (UL)		14...8			14...1/0			10...1/0		
Dos conductores - conductor de abajo										
mm <sup>2</sup>		1...16	1,5...16	1...16	2,5...25	6...35	2,5...35	4...35	6...35	4...35
AWG (UL)		14...8			14...1/0			10...1/0		
Dos conductores - conductor de arriba										
mm <sup>2</sup>		0,75...16	1...16	0,75...16	1...25	1,5...35	1...35	1,5...50	2,5...50	1,5...50
AWG (UL)		14...8			14...1/0			10...1/0		
Par de apriete (N.m)		2...2,5			4...6			5...6,5		
Par de apriete (lb.in) (UL)		22			40			60		

Referencia		CWM112 / CWM150		CWM180 / CWM215		CWM250 / CWM300		CWM400		CWM450 / CWM560		CWM500 / CWM630 / CWM800	
Tipo de tornillo		M6 Cabeza hexagonal		M8 Cabeza hexagonal		M10 Cabeza hexagonal		M12 Cabeza hexagonal		M10 Cabeza hexagonal		M16 Cabeza hexagonal	
Capacidad del terminal principal		Hilo y cable com terminal	Barras	Hilo y cable con terminal	Barras	Hilo y cable con terminal	Barras	Hilo y cable con terminal	Barras	Hilo y cable com terminal	Barras	Hilo y cable con terminal	Barras
mm <sup>2</sup>		2x 25...70	2 x (15 x 3)	2x 50...120	2 x (20 x 3)	2x 50...150	2 x (30 x 5)	2x 120...185	2x (30x5)	2x 50...240	2x(40x5)	2x 185...300	2x (60x5)
AWG (UL)		2x 2...3/0	-	2x 1/0...250	-	2x 1/0...300	-	2x 250...400	-	2x 1/0...500	-	2x 400...600	-
Par de apriete (N.m)		5,4...6		14...16		23...26		23...26		24		54...60	

Nota: 1) Esta información es válida para los terminales de los contactos auxiliares, incorporados para CWM9 a CWM18.

## Contadores CWM - Características Técnicas

### Capacidad de los Terminales e Par de Apriete - Terminales de la Bobina

Referencia	CWM9...105			CWM112...300		
Tipo de tornillo	M3,5 x 10 Plana / Phillips			M3,5 x 10 Plana / Phillips		
Terminales de la bobina	Cable con terminal	Cable sin terminal	Hilo	Cable con terminal	Cable sin terminal	Hilo
mm <sup>2</sup>	1x 0,5...4 2x 0,5...1,5 2x 1...2,5	1x 1...4 2x 1...2,5	1x 0,5...4 2x 0,5...1,5 2x 1...2,5	1x 0,5...4 2x 0,5...1,5 2x 1...2,5	1x 1...4 2x 1...2,5	1x 0,5...4 2x 0,5...1,5 2x 1...2,5
AWG (UL)	1x 20...10 2x 20...14 2x 16...12	1x 16...10 2x 16...12	1x 20...10 2x 20...14 2x 16...12	1x 20...10 2x 20...14 2x 16...12	1x 16...10 2x 16...12	1x 20...10 2x 20...14 2x 16...12
Par de apriete (N.m)	0,8...1,1			0,8...1,1		
Par de apriete (lb.in) (UL)	10			10		

Referencia	CWM450 / CWM560			CWM400 / CWM500 / CWM630 / CWM800		
Tipo de tornillo	M3,5 Plana / Phillips			M4 Plana / Phillips		
Terminales de la bobina	Cable con terminal	Cable sin terminal	Hilo	Cable con terminal	Cable sin terminal	Hilo
mm <sup>2</sup>	2 x 1...2,5			1x 1,25...5,5 or 2x 1,25...5,5		
AWG (UL)	-			16...10		
Par de apriete (N.m)	0,8...1,1			2...2,3		
Par de apriete (lb.in) (UL)	-			17,7...20,3		

### Capacidad de los Terminales e Par de Apriete - Bloques de Contactos Auxiliares

Referencia	BLB			BCXMF BCXML		
Tipo de tornillo	M3,5 Plana / Phillips			M3,5 x 9 Fenda / Phillips		
Bloque de contacto auxiliar	Cable con terminal	Cable sin terminal	Hilo	Cable con terminal	Cable sin terminal	Hilo
mm <sup>2</sup>	2 x 1...2,5			1x 0,5...4 2x 0,5...2,5	1x 0,75...2,5 2x 0,75...2,5	1x 0,5...4 2x 0,5...2,5
AWG (UL)	-			22...12		
Par de apriete (N.m)	1,0			0,8...1,1		
Par de apriete (lb.in) (UL)	-			10		



## Contadores CWM - Características Técnicas

### Contactos Auxiliares

Referencia		CWM9	CWM12	CWM18	BCXMF...	BCXML...	BLB
Tensión nominal de aislamiento $U_i$ IEC/EN 60 947 UL	(V) (V)		1.000 600			1.000 600	1.000 600
Tensión nominal de operación $U_e$	(V)		690			690	690
Corriente térmica convencional $I_{th}$	(A)		16			10	10
Corriente nominal de operación $I_e$ AC-15 220 - 240 V 380 - 400 V 415 V 500 V UL	(A) (A) (A) (A) (A)		10 6 5 4 A600		6 4 3,5 2,5 A600	4 3 - 2 -	10 4 4 2,5 A600
DC-13 24 V 48 V 110 V 220 V UL	(A) (A) (A) (A) (A)		6 4 2 0,7 P600		6 4 2 0,7 Q600	4 2 0,55 0,3 -	4 2 0,7 0,3 Q600
Capacidad de conexión $I_m$ AC-15 DC-13	$U_e \leq 400$ V 50/60 Hz $U_e \leq 220$ V cc	(A) (A)	250 250		90 90	90 90	10 x $I_e$ 1,1 x $I_e$
Capacidad de desconexión $I_c$ AC-15 DC-13	$U_e \leq 400$ V 50/60 Hz $U_e \leq 220$ V cc	(A) (A)	250 2		60 0,95	60 0,95	10 x $I_e$ 1,1 x $I_e$
Fusible máximo gL/gG	(A)		10			10	10
Confiabilidad del circuito de control			$I_e \text{ min} = 5 \text{ mA}$ . $U_e \text{ min} = 17 \text{ V}$			$I_e \text{ min} = 1 \text{ mA}$ $U_e \text{ min} = 17 \text{ V}$	5 mA 17 V
Vida eléctrica	Ops		10 <sup>6</sup>				
Vida mecánica	Ops		15 x 10 <sup>6</sup>			10 x 10 <sup>6</sup>	

Referencia		BCXML11 CWM800 / BCXMR11 CWM800	
Corriente térmica convencional $I_{th}$	(A)	16	
Corriente nominal de operación $I_e$ Categoría de servicio (A600)	110 V (A) 220 V (A) 440 V (A) 600 V (A)	AC-15 6 5 3 3	AC-12 10 10 5 5
Categoría de servicio (P600)	24 V (A) 48 V (A) 110 V (A) 220 V (A)	DC-13 6 3 1,2 0,2	DC-12 5 3 1,3 0,25
Vida mecánica	Ops x 10 <sup>6</sup>	10	
Vida eléctrica Operaciones x 10 <sup>6</sup>	AC-15	0,5	
	AC-12	0,25	
	DC-13 / DC-12	0,5	
Numero máximo de maniobras por hora		1.800	

# Contadores CWM - Características Técnicas

## Contadores para Circuitos de Iluminación

Tipo de lámpara	W	A	μF	Número máximo de lámparas por fase 220 V										
				CWM9	CWM12	CWM18	CWM25	CWM32	CWM40	CWM50	CWM65	CWM80	CWM95	CWM105
Incandescente	60	0,27	-	62	62	70	77	85	122	156	191	222	264	284
	100	0,45	-	40	40	50	60	66	73	95	116	133	160	170
	200	0,91	-	20	20	25	30	33	36	47	58	66	79	84
	300	1,36	-	13	13	17	20	22	24	31	38	44	53	56
	500	2,27	-	8	8	10	12	12	14	19	23	26	31	33
	1.000	4,50	-	4	4	5	6	6	7	9	11	13	16	16
	2.000	9,1	-	1	1	2	3	3	3	4	5	6	8	8
	AC-5b <sup>1)</sup> (A)			18	18	23	27	30	33	43	52	60	73	77
Fluorescente sin compensación	15	0,23	-	88	98	126	155	224	237	355	390	434	496	553
	20	0,37	-	57	61	78	110	139	147	221	243	270	309	344
	40	0,44	-	48	51	66	93	118	124	186	204	227	260	289
	65	0,7	-	30	32	41	58	74	78	116	127	142	163	181
	100	1,5	-	14	16	19	27	34	36	54	59	66	76	85
Fluorescente con compensación	15	0,23	3,5	61	77	94	111	134	149	191	232	273	312	347
	20	0,25	4,5	48	61	74	87	103	115	148	180	212	243	270
	40	0,3	4,5	48	61	74	87	103	115	148	180	212	243	270
	65	0,45	7	31	39	47	56	66	74	95	115	136	155	173
	100	0,7	18	11	14	17	21	23	29	37	45	53	60	67
Lámparas de mercurio de alta presión sin compensación	250	2,13	-	6	8	10	12	15	18	27	30	33	36	42
	400	3,25	-	4	5	6	8	10	12	18	20	22	24	28
	700	5,4	-	2	3	4	5	6	7	11	12	13	14	17
	1.000	7,5	-	2	2	3	3	4	5	8	9	9	10	12
Lámparas de mercurio de alta presión con compensación	250	1,3	20	11	14	18	22	27	33	49	55	60	66	77
	400	2,1	25	7	9	11	14	17	20	31	34	37	41	48
	700	3,6	40	4	5	6	8	10	12	18	20	22	24	28
	1.000	5,3	60	3	3	4	5	7	8	12	13	15	16	19
Lámpara de sodio de alta presión sin compensación	250	3	-	4	5	7	9	11	13	19	21	24	26	30
	400	4,4	-	3	4	5	6	7	9	13	15	16	18	20
	1.000	10,3	-	1	2	2	2	3	4	6	6	7	7	9
Lámpara de sodio de alta presión con compensación	250	1,45	40	10	12	16	20	25	30	44	49	54	59	69
	400	2,5	45	6	7	9	11	14	17	26	29	31	34	40
	1.000	5,5	100	3	3	4	5	6	8	12	13	14	16	18
Yoduro metálico sin compensación	250	2,17	-	4	5	7	9	12	12	19	21	23	25	29
	400	3,48	-	3	3	4	6	8	8	12	13	14	16	18
	700	6,09	-	1	2	2	3	4	4	7	7	8	9	10
	1.000	8,7	-	1	1	2	2	3	3	5	5	6	6	7
	2.000	17,39	-	1	1	1	1	2	2	2	3	3	3	4
Yoduro metálico con compensación	250	1,4	32	7	9	11	16	21	21	32	36	39	43	50
	400	2	45	5	6	8	11	15	15	23	25	28	30	35
	700	3,6	65	3	3	4	6	8	8	13	14	15	17	19
	1.000	5,3	85	2	2	3	4	6	6	8	9	10	11	13
	2.000	10,6	100	1	1	2	2	3	3	4	5	5	6	7

Nota: 1) Valores indicativos - Es altamente recomendado considerar los valores de corriente de cierre y nominales AC-1 cuando seleccionar el contador para categoría de servicio AC-5b (AC-5b - Maniobra de lámparas incandescentes).

# Contadores CWM - Características Técnicas

## Contadores para Circuitos de Iluminación

Tipo de lámpara	W	A	μF	Número máximo de lámparas por fase 220 V					
				CWM112	CWM150	CWM180	CWM215	CWM250	CWM300
Incandescente	60	0,27	-	318	404	467	523	578	667
	100	0,45	-	193	245	283	317	350	404
	200	0,91	-	95	121	140	157	173	200
	300	1,36	-	64	81	93	105	116	133
	500	2,27	-	38	49	56	63	69	80
	1.000	4,50	-	19	24	28	31	35	40
	2.000	9,1	-	10	12	14	16	17	20
	AC-5b <sup>1)</sup> (A)			87	110	127	142	158	182
Fluorescente sin compensación	15	0,23	-	652	815	978	1.236	1.522	1.783
	20	0,37	-	405	507	608	769	946	1.108
	40	0,44	-	341	426	511	646	795	932
	65	0,7	-	214	268	321	406	500	586
	100	1,5	-	100	125	150	190	233	273
Fluorescente con compensación	15	0,23	3,5	409	520	600	700	743	857
	20	0,25	4,5	318	404	467	545	578	667
	40	0,3	4,5	318	404	467	545	578	667
	65	0,45	7	204	260	300	350	371	429
	100	0,7	18	79	101	117	136	144	167
Lámparas de mercurio de alta presión sin compensación	250	2,13	-	54	62	68	90	106	124
	400	3,25	-	36	40	45	59	69	81
	700	5,4	-	21	24	27	36	42	49
	1.000	7,5	-	15	18	19	26	30	35
Lámparas de mercurio de alta presión con compensación	250	1,3	20	79	100	116	133	143	165
	400	2,1	25	63	80	92	101	114	132
	700	3,6	40	39	50	58	62	72	83
	1.000	5,30	60	26	33	39	42	48	55
Lámpara de sodio de alta presión sin compensación	250	3,0	-	39	44	48	64	75	88
	400	4,4	-	26	30	33	44	51	60
	1.000	10,3	-	11	13	14	19	22	26
Lámpara de sodio de alta presión con compensación	250	1,45	40	45	57	66	78	81	94
	400	2,5	45	40	51	58	64	72	83
	1.000	5,5	100	18	23	26	29	33	38
Yoduro metálico sin compensación	250	2,17	-	37	42	47	61	73	85
	400	3,48	-	23	26	29	38	45	53
	700	6,09	-	13	15	17	22	26	30
	1.000	8,7	-	9	11	12	15	18	21
	2.000	17,39	-	5	5	6	8	9	11
Yoduro metálico con compensación	250	1,4	32	56	71	82	94	102	117
	400	2	45	40	51	58	66	72	83
	700	3,6	65	28	35	40	44	50	58
	1.000	5,3	85	21	27	31	33	38	44
	2.000	10,6	100	18	23	26	28	33	38

Nota: 1) Valores indicativos - Es altamente recomendado considerar los valores de corriente de cierre y nominales AC-1 cuando seleccionar el contador para categoría de servicio AC-5b (AC-5b - Maniobra de lámparas incandescentes).

# Contadores CWM - Características Técnicas

## CC - Categoría de Servicio para Contactores

### Categoría de Servicio DC-1 (L/R ≤1ms)

Referencia		CWM9	CWM12	CWM18	CWM25	CWM32	CWM40	CWM50	CWM65	CWM80	CWM95	CWM105
U <sub>e</sub>	Polos en serie	Corriente máxima de operación I <sub>e</sub> (A)										
≤24 V	1	18	18	18	25	32	40	50	65	65	80	80
	2	25	25	32	45	60	60	90	110	110	140	140
	3	25	25	32	45	60	60	90	110	110	140	140
	4	25	25	32	-							
≤48 V	1	15	15	15	20	25	35	45	55	55	70	70
	2	25	25	32	45	60	60	90	110	110	140	140
	3	25	25	32	45	60	60	90	110	110	140	140
	4	25	25	32	-							
≤60 V	1	12	12	12	18	18	32	40	50	50	65	65
	2	25	25	32	45	60	60	90	110	110	140	140
	3	25	25	32	45	60	60	90	110	110	140	140
	4	25	25	32	-							
≤125 V	1	6	6	6	8	8	8	16	16	16	16	16
	2	18	18	18	25	45	45	80	90	90	110	110
	3	25	25	25	32	60	60	90	110	110	140	140
	4	25	25	32	-							
≤220 V	1	0,8	0,8	0,8	0,8	1	1	2	2	2	2	2
	2	7,5	7,5	7,5	8	8	8	20	20	20	20	20
	3	25	25	25	32	50	50	90	110	110	140	140
	4	25	25	32	-							
≤440 V	1	0,4	0,4	0,4	0,4	0,5	0,5	0,8	0,8	0,8	0,8	0,8
	2	0,8	0,8	0,8	0,8	1	1	2	2	2	2	2
	3	8	8	8	10	10	10	15	15	15	15	15
	4	15	15	15	-							
≤600 V	1	-	-	-	-	-	-	-	-	-	-	-
	2	0,4	0,4	0,4	0,4	0,5	0,5	1	1	1	1	1
	3	4	4	4	5	5	5	7,5	7,5	7,5	7,5	7,5
	4	8	8	10	-							

### Categoría de Servicio DC-3 (L/R ≤2.5ms)

Referencia		CWM9	CWM12	CWM18	CWM25	CWM32	CWM40	CWM50	CWM65	CWM80	CWM95	CWM105
U <sub>e</sub>	Polos en serie	Corriente máxima de operación I <sub>e</sub> (A)										
≤24 V	1	12	12	12	18	25	32	40	50	50	65	65
	2	18	18	18	25	40	40	65	80	80	105	105
	3	18	18	18	25	40	40	65	80	80	105	105
	4	18	18	18	-							
≤48 V	1	9	9	9	12	18	20	30	35	35	45	45
	2	18	18	18	25	40	40	65	80	80	105	105
	3	18	18	18	25	40	40	65	80	80	105	105
	4	18	18	18	-							
≤60 V	1	7,5	7,5	7,5	10	15	15	25	30	30	35	35
	2	18	18	18	25	40	40	65	80	80	105	105
	3	18	18	18	25	40	40	65	80	80	105	105
	4	18	18	18	-							
≤125 V	1	2	2	2	2	3	3	3	3	3	3	3
	2	10	10	12	18	25	32	50	60	60	85	85
	3	15	15	18	25	32	40	65	80	80	105	105
	4	15	15	18	-							
≤220 V	1	0,6	0,6	0,6	0,6	0,6	0,6	0,8	0,8	0,8	0,8	0,8
	2	2	2	2	2	2	2	7	7	7	7	7
	3	12	12	12	18	25	32	50	65	65	95	95
	4	12	15	18	-							
≤440 V	1	-	-	-	-	-	-	-	-	-	-	-
	2	0,3	0,3	0,3	0,3	0,5	0,5	1	1	1	1	1
	3	1,5	1,5	1,5	1,5	3	3	3	3	3	3	3
	4	1,5	6	6	-							
≤600 V	1	-	-	-	-	-	-	-	-	-	-	-
	2	-	-	-	-	-	-	-	-	-	-	-
	3	0,8	0,8	0,8	0,8	1,5	1,5	1,5	1,5	1,5	1,5	1,5
	4	1	2,5	2,5	-							

## Contadores CWM - Características Técnicas

### CC - Categoría de Servicio para Contactores

#### Categoría de Servicio DC-5 (L/R ≤15ms)

Referencia	CWM9	CWM12	CWM18	CWM25	CWM32	CWM40	CWM50	CWM65	CWM80	CWM95	CWM105	
$U_e$	Polos en serie											
	Corriente máxima de operación $I_e$ (A)											
≤24 V	1	12	12	12	18	25	32	40	50	50	65	65
	2	18	18	18	25	40	40	65	80	80	105	105
	3	18	18	18	25	40	40	65	80	80	105	105
	4	18	18	18	-							
≤48 V	1	9	9	9	12	18	20	30	35	35	45	45
	2	18	18	18	25	40	40	65	80	80	105	105
	3	18	18	18	25	40	40	65	80	80	105	105
	4	18	18	18	-							
≤60 V	1	7,5	7,5	7,5	10	15	15	25	30	30	35	35
	2	18	18	18	25	40	40	65	80	80	105	105
	3	18	18	18	25	40	40	65	80	80	105	105
	4	18	18	18	-							
≤125 V	1	0,8	0,8	0,8	0,8	1,2	1,2	1,2	1,2	1,2	1,2	1,2
	2	5	5	5	5	5	5	50	60	60	80	80
	3	15	15	15	20	25	32	60	70	70	95	95
	4	15	15	18	-							
≤220 V	1	-	-	-	-	-	-	0,5	0,5	0,5	0,5	0,5
	2	0,8	0,8	0,8	0,8	0,8	0,8	3	3	3	4	4
	3	3	3	3	3	3	3	7	7	7	7	7
	4	10	10	10	-							
≤440 V	1	-	-	-	-	-	-	-	-	-	-	-
	2	-	-	-	-	-	-	-	-	-	-	-
	3	0,4	0,5	0,5	0,5	0,7	0,7	1	1	1	1	1
	4	1,5	2	2	-							
≤600 V	1	-	-	-	-	-	-	-	-	-	-	-
	2	-	-	-	-	-	-	-	-	-	-	-
	3	-	-	-	-	-	-	-	-	-	-	-
	4	0,5	0,75	0,75	-							

#### Categoría de Servicio DC-1 (L/R ≤1ms)

Referencia	CWM112	CWM150	CWM180	CWM215	CWM250	CWM300
$U_e$	Polos en serie					
	Corriente máxima de operación $I_e$ (A)					
≤24 V	1	160	160	200	200	300
	2	180	225	225	315	350
	3	180	225	225	315	350
≤110 V	1	18	18	18	18	33
	2	112	150	170	200	250
	3	180	225	225	315	350
≤220 V	1	-	-	-	-	-
	2	90	120	140	160	200
	3	180	225	225	315	350
≤440 V	1	-	-	-	-	-
	2	-	-	-	-	-
	3	85	105	105	150	165



## Contadores CWM - Características Técnicas

### CC - Categoría de Servicio para Contactores

#### Categoría de Servicio DC-3 / DC-5 (L/R ≤15ms)

Referencia		CWM112	CWM150	CWM180	CWM215	CWM250	CWM300
U <sub>e</sub>	Polos en serie	Corriente máxima de operación I <sub>e</sub> (A)					
≤24 V	1	112	112	180	180	250	250
	2	112	150	180	215	250	300
	3	112	150	180	215	250	300
≤110 V	1	18	18	18	18	33	33
	2	80	95	105	150	185	205
	3	112	150	180	215	250	300
≤220 V	1	-	-	-	-	-	-
	2	55	55	65	65	70	80
	3	80	120	150	180	200	200
≤440 V	1	-	-	-	-	-	-
	2	-	-	-	-	-	-
	3	27	40	50	60	67	67

#### Categoría de Servicio DC-1 (L/R ≤1ms)

Referencia		CWM400	CWM500	CWM630	CWM800
U <sub>e</sub>	Polos en serie	Corriente máxima de operación I <sub>e</sub> (A)			
≤24 V	2	400	580	630	800
	3	400	580	630	800
≤48 V	2	240	580	630	800
	3	400	580	630	800
≤110 V	2	200	520	630	630
	3	400	580	630	800
≤220 V	2	200	450	630	630
	3	300	580	630	800

#### Categoría de Servicio DC-2 / DC-4 (L/R ≤15ms)

Referencia		CWM400	CWM500	CWM630	CWM800
U <sub>e</sub>	Polos en serie	Corriente máxima de operación I <sub>e</sub> (A)			
≤24 V	2	400	580	630	800
	3	400	580	630	800
≤48 V	2	200	580	630	630
	3	280	580	630	630
≤110 V	2	150	500	630	630
	3	200	550	630	630
≤220 V	2	90	480	630	630
	3	150	500	630	630

#### 1 Polo en Serie



#### 3 Polos en Serie

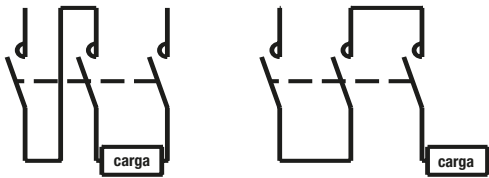

#### 2 Polos en Serie

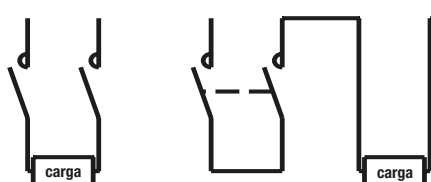

#### 4 Polos en Serie

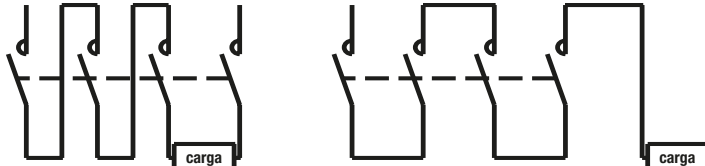



# Contadores CWM - Características Técnicas

## Marcación de los Terminales EN 50012

Diagrama	Numero distintivo y versión de combinación	NA	NC	Referencia	Bloques de contactos adicionales
Sin bloque de contacto auxiliar					
	10E	1	0	CWM9-10 CWM12-10 CWM18-10	-
	01E	0	1	CWM9-01 CWM12-01 CWM18-01	-
Bloques de contactos auxiliares de montaje frontal BCXMF10 o BCXMF01					
	11E	1	1	CWM9-10 CWM12-10 CWM18-10	+ BCXMF01
	21E	2	1	CWM9-10 CWM12-10 CWM18-10	+ BCXMF10 + BCXMF01
	12E	1	2	CWM9-10 CWM12-10 CWM18-10	+ 2 BCXMF01
	31E	3	1	CWM9-10 CWM12-10 CWM18-10	+ 2 BCXMF10 + BCXMF01
	41E	4	1	CWM9-10 CWM12-10 CWM18-10	+ 3 BCXMF10 + BCXMF01















## Contadores CWM - Características Técnicas

### Marcación de los Terminales EN 50012

Diagrama	Numero distintivo y versión de combinación	NA	NC	Referencia	Bloques de contactos adicionales
<b>Bloques de contactos auxiliares de montaje frontal BCXMF10 o BCXMF01</b>					
	22E	2	2	CWM9-10 CWM12-10 CWM18-10	+ 2 BCXMF01 + BCXMF10
	32E	3	2	CWM9-10 CWM12-10 CWM18-10	+ 2 BCXMF01 + 2 BCXMF10
	13E	1	3	CWM9-10 CWM12-10 CWM18-10	+ 3 BCXMF01
	23E	2	3	CWM9-10 CWM12-10 CWM18-10	+ 3 BCXMF01 + BCXMF10
<b>Bloques de contactos auxiliares laterales con 2 contactos por bloque</b>					
	11E	1	1	CWM25-00 hasta CWM105-00	+ BCXML11
	31E	3	1	CWM25-00 hasta CWM105-00	+ BCXML11 + BCXML20
	22E	2	2	CWM25-00 hasta CWM105-00	+ 1 BCXML11 + 1 BCXMR11
<b>Sin bloque de contacto auxiliar</b>					
	-	0	0	CWM25-00 hasta CWM105-00	-
<b>Bloques de contactos auxiliares de montaje frontal BCXMF10 o BCXMF01</b>					
	10E	1	0	CWM25-00 hasta CWM105-00	+ BCXMF10
	01E	0	1	CWM25-00 hasta CWM105-00	+ BCXMF01







# Contadores CWM - Características Técnicas

## Marcación de los Terminales EN 50012

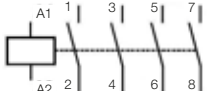
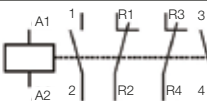
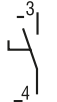
Diagrama	Numero distintivo y versión de combinación	NA	NC	Referencia	Bloques de contactos adicionales
<b>Bloques de contactos auxiliares de montaje frontal BCXMF10 o BCXMF01</b>					
	11E	1	1	CWM25-00 hasta CWM105-00	+ BCXMF10 + BCXMF01
	21E	2	1	CWM25-00 hasta CWM105-00	+ 2 BCXMF10 + BCXMF01
	12E	1	2	CWM25-00 hasta CWM105-00	+ BCXMF10 + 2 BCXMF01
	31E	3	1	CWM25-00 hasta CWM105-00	+ 3 BCXMF10 + BCXMF01
	41E	4	1	CWM50-00 hasta CWM105-00	+ 4 BCXMF10 + BCXMF01
	22E	2	2	CWM25-00 hasta CWM105-00	+ 2 BCXMF01 + 2 BCXMF10
	32E	3	2	CWM50-00 hasta CWM105-00	+ 2 BCXMF01 + 3 BCXMF10
	13E	1	3	CWM25-00 hasta CWM105-00	+ BCXMF10 + 3 BCXMF01
	23E	2	3	CWM50-00 hasta CWM105-00	+ 3 BCXMF01 + 2 BCXMF10
<b>Contadores sin bloques de contactos auxiliares + bloques de contactos auxiliares laterales con 2 contactos por bloque</b>					
	22	2	2	CWM112-22-30♦ hasta CWM800-22-30♦ <sup>1)</sup>	+ 2 BCXML11
	44	4	4	CWM112-22-30♦ hasta CWM800-22-30♦ <sup>1)</sup>	+ 2 BCXML11 + 2 BCXMR11
	22	2	2	CWM450-22-30♦ y CWM560-22-30♦	+ 2BLB-11
	44	4	4	CWM450-22-30♦ y CWM560-22-30♦	+ 2BLB-11 + 2BLRB-11



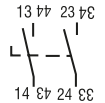
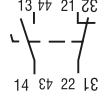
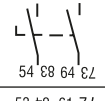
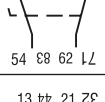
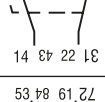



## Contadores CWM - Características Técnicas

### Marcación de los Terminales EN 50012

Diagrama	Configuración	Contactos de potencia		Referencia
		NA	NC	
<b>Contadores 4 polos</b>				
	-	4	0	CWM9-00-40 ♦ CWM12-00-40 ♦ CWM18-00-40 ♦
	-	2	2	CWM9-00-22 ♦ CWM12-00-22 ♦ CWM18-00-22 ♦
Diagrama	Configuración	Contactos auxiliares		Referencia
		NA	NC	
<b>Bloques de contactos auxiliares de montaje frontal BCXMF10 o BCXMF01</b>				
	10	1	0	BCXMF10
	01	0	1	BCXMF01
	10	1	0	BCXMF10
	01	0	1	BCXMF01
Diagrama	Configuración	Contactos auxiliares		Referencia
		NA	NC	
<b>Bloques de contactos auxiliares laterales con 2 contactos por bloque</b>				
	20	2	0	BCXML20
	11	1	1	BCXML11
	20	2	0	BCXML20
	11	1	1	BCXML11
	11	1	1	BCXML11 CWME800
	11			BCXML11 CWME800

# Contactores CWM - Características Técnicas

## Marcación de los Terminales EN 50012

Diagrama	Configuración	Contactos auxiliares		Referencia
		NA	NC	
<b>Bloques de contactos auxiliares laterales con 2 contactos por bloque</b>				
	11	1	1	BLB11
	20	2	0	BLB20
	02	0	2	BLB02
	11	1	1	BLRB11
	20	2	0	BLRB20
	02	0	2	BLRB02
<b>Enclavamiento mecánico y eléctrico para contactores</b>				
	02	0	2	BLIM.02



# Contadores CWM - Características Técnicas

## Curvas de Vida Eléctrica

Categoría AC-3 ( $U_e \leq 440$  V ca)

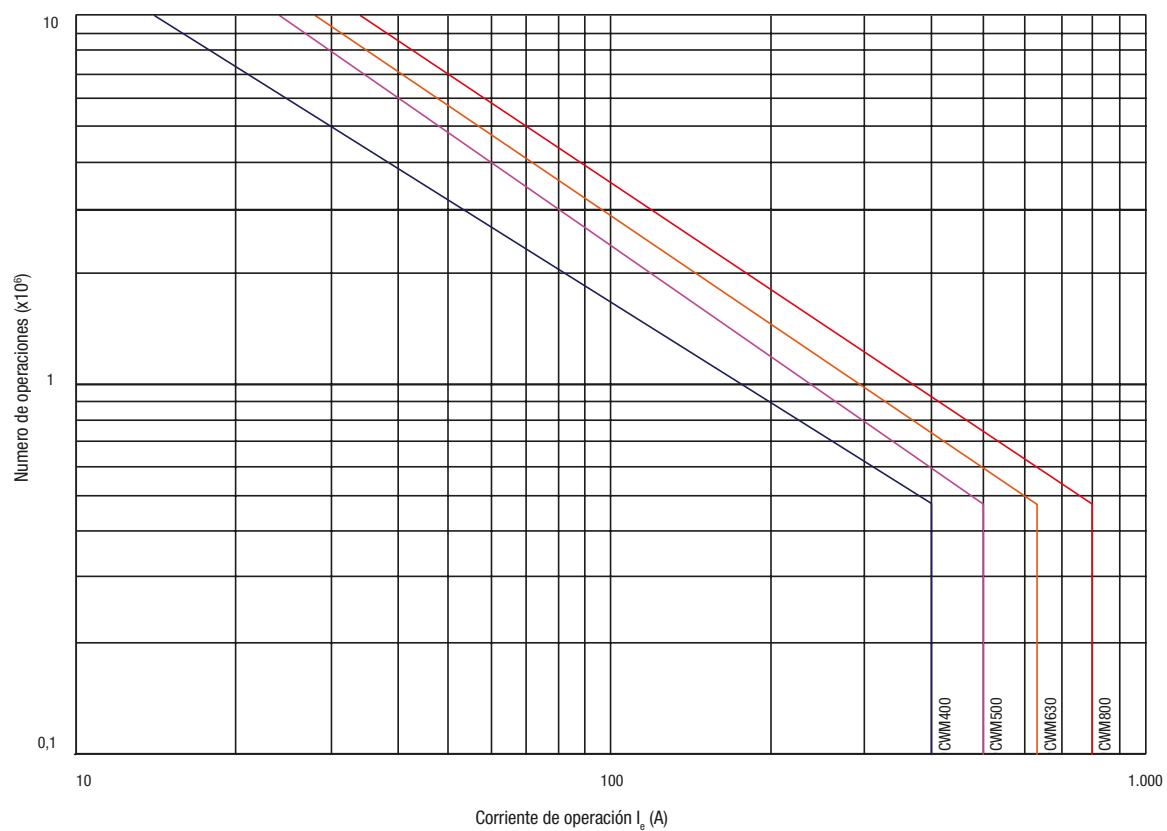
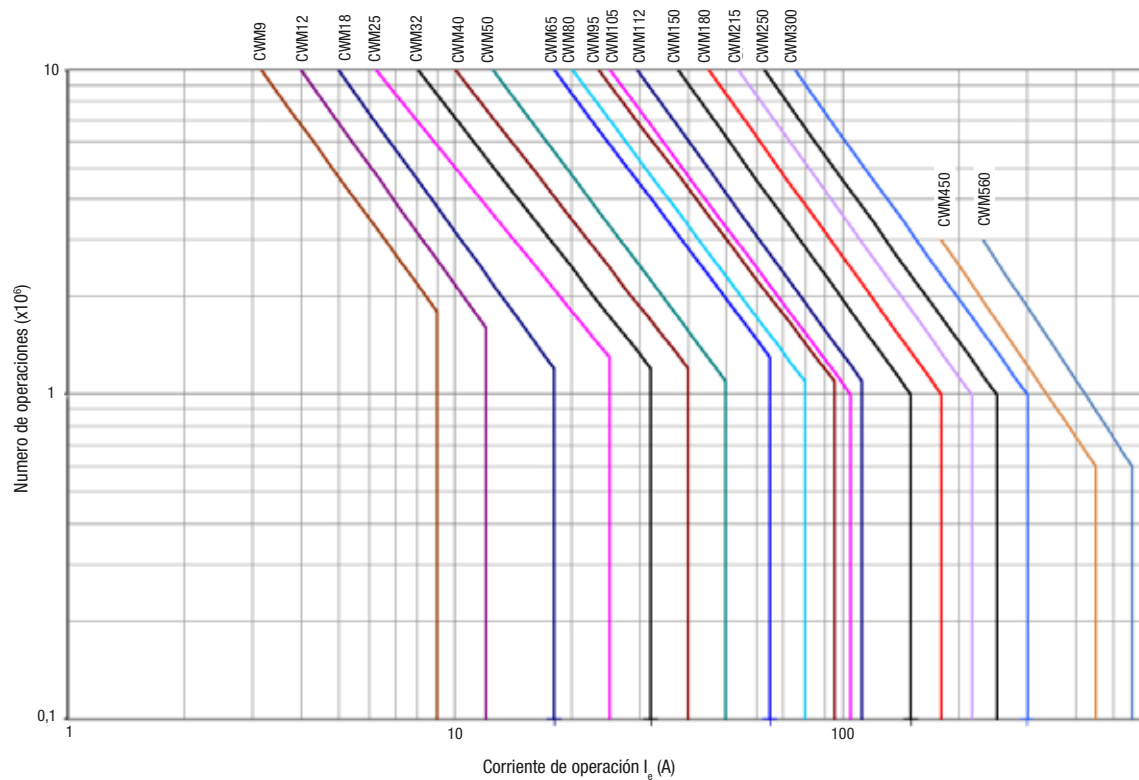

# Contactores CWM - Características Técnicas

## Curvas de Vida Eléctrica

### Categoría AC-4 ( $U_e \leq 440$ V ca)

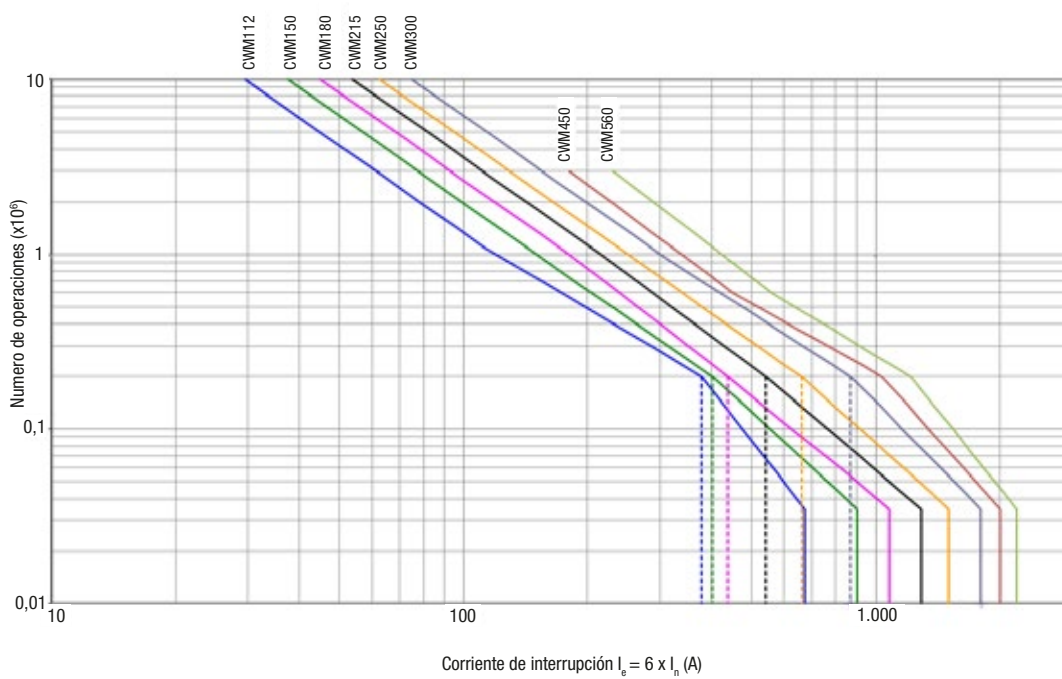
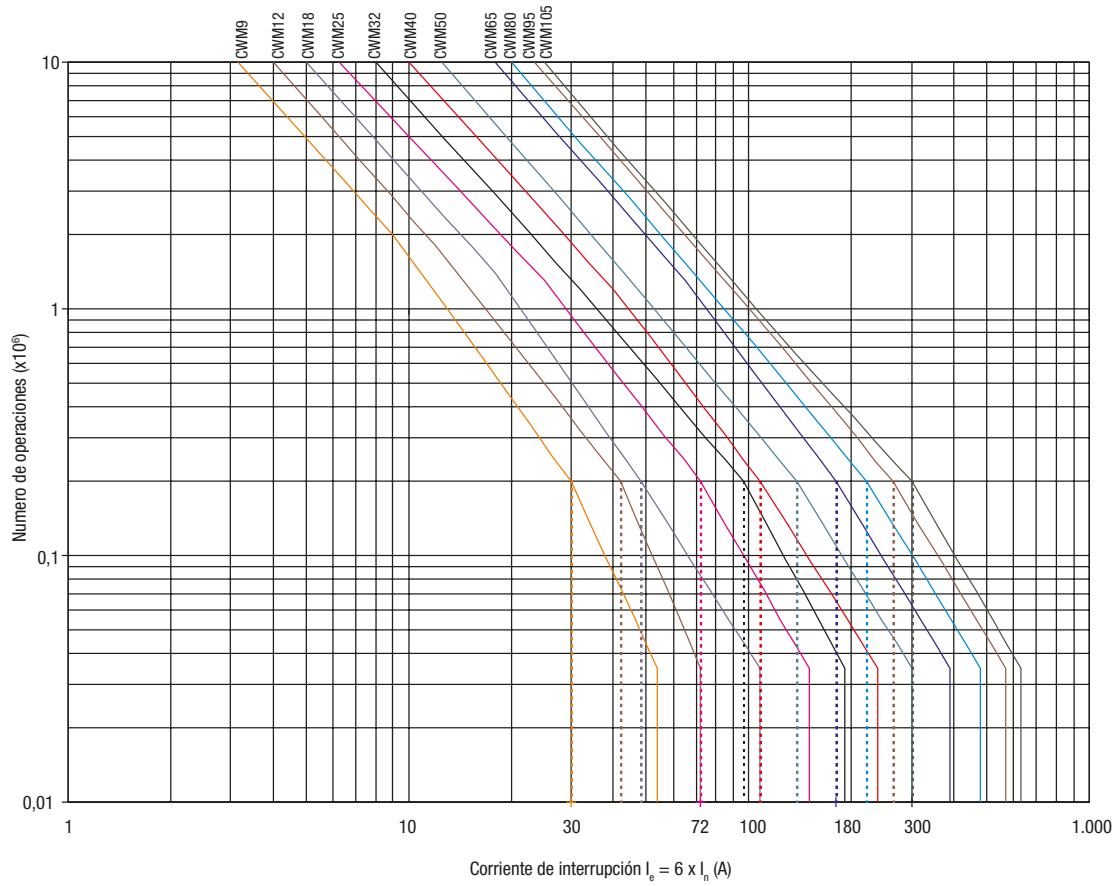

# Contactores CWM - Características Técnicas

## Curvas de Vida Eléctrica

### Categoría AC-4 ( $U_e \leq 440$ V ca)

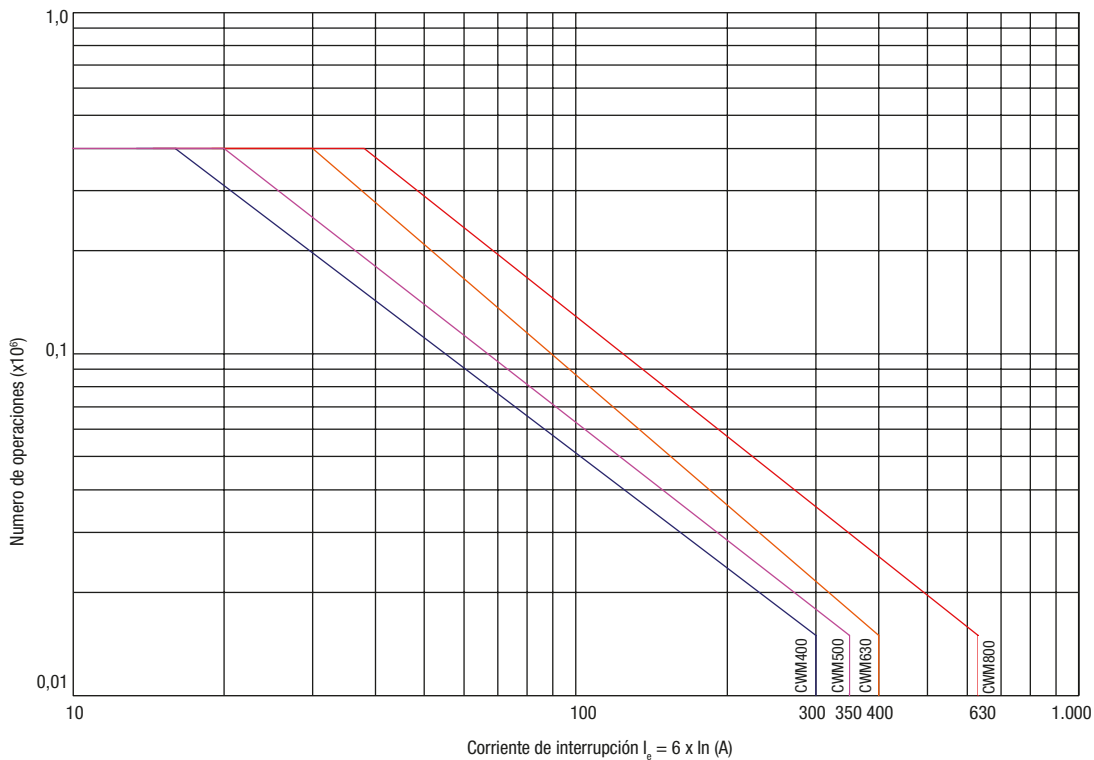

### Categoría AC-1 ( $U_e \leq 690$ V ca)

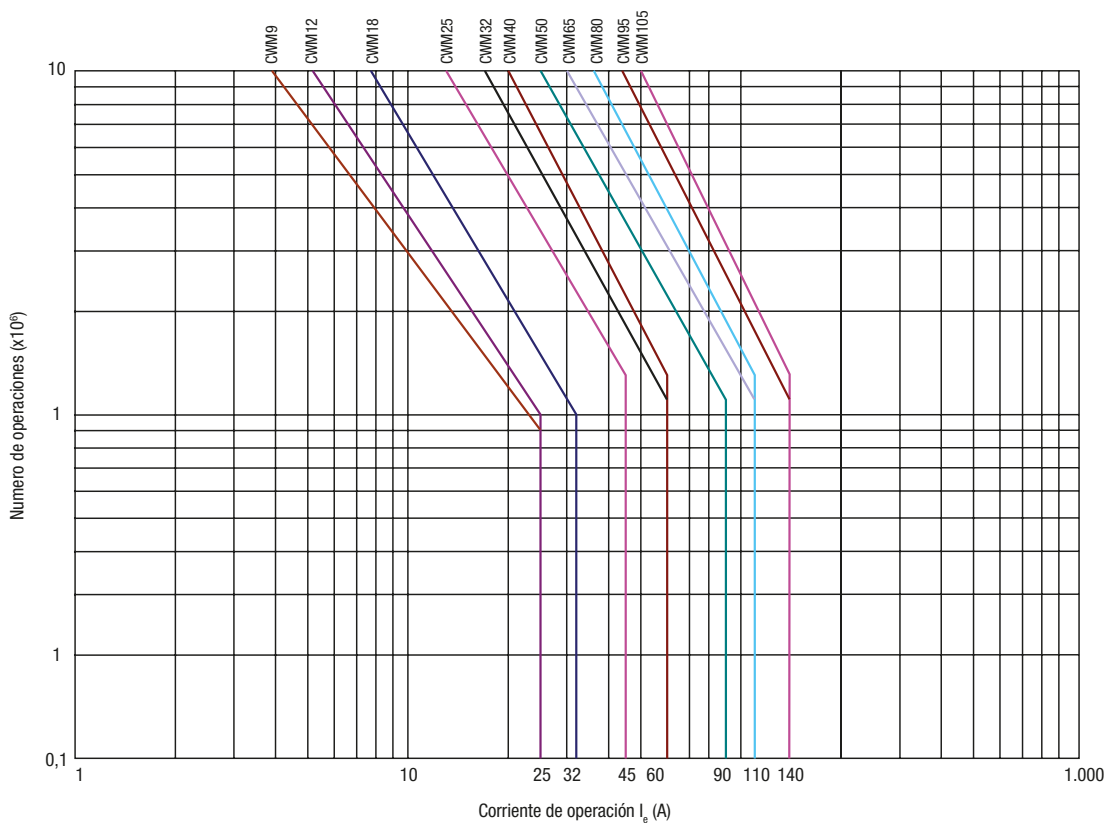



# Contactores CWM - Características Técnicas

## Curvas de Vida Eléctrica

Categoría AC-1 ( $U_e \leq 690$  V ca)

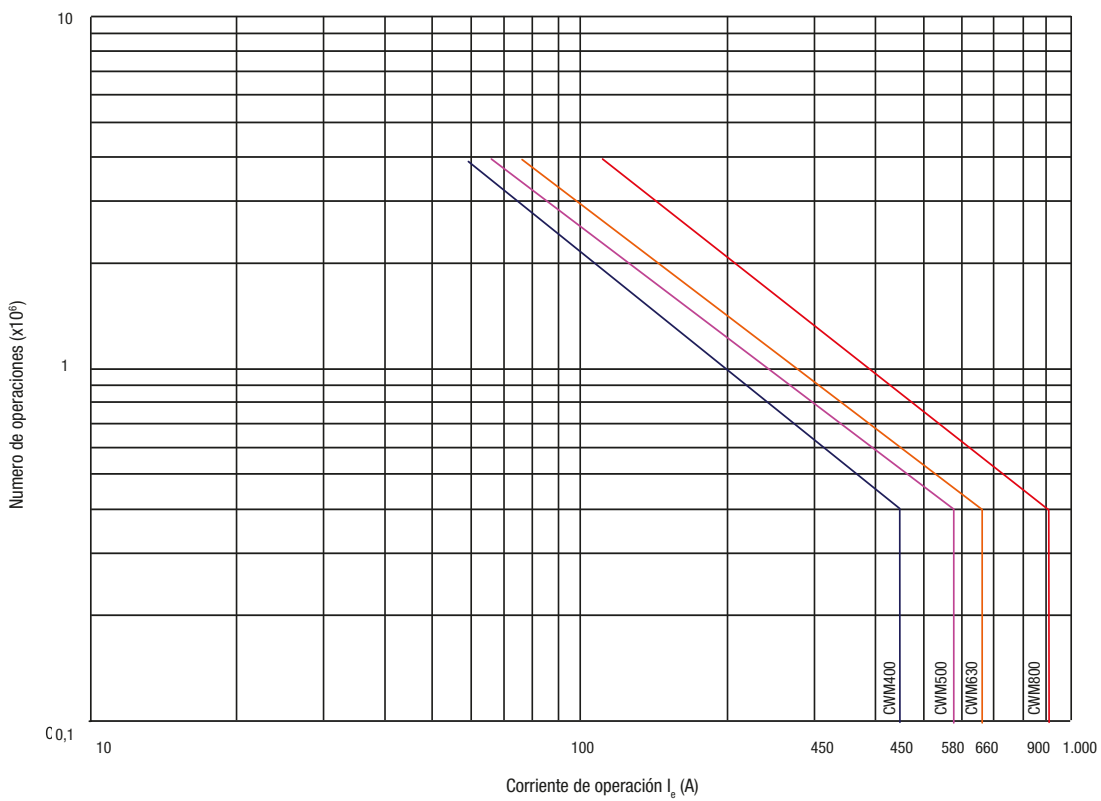
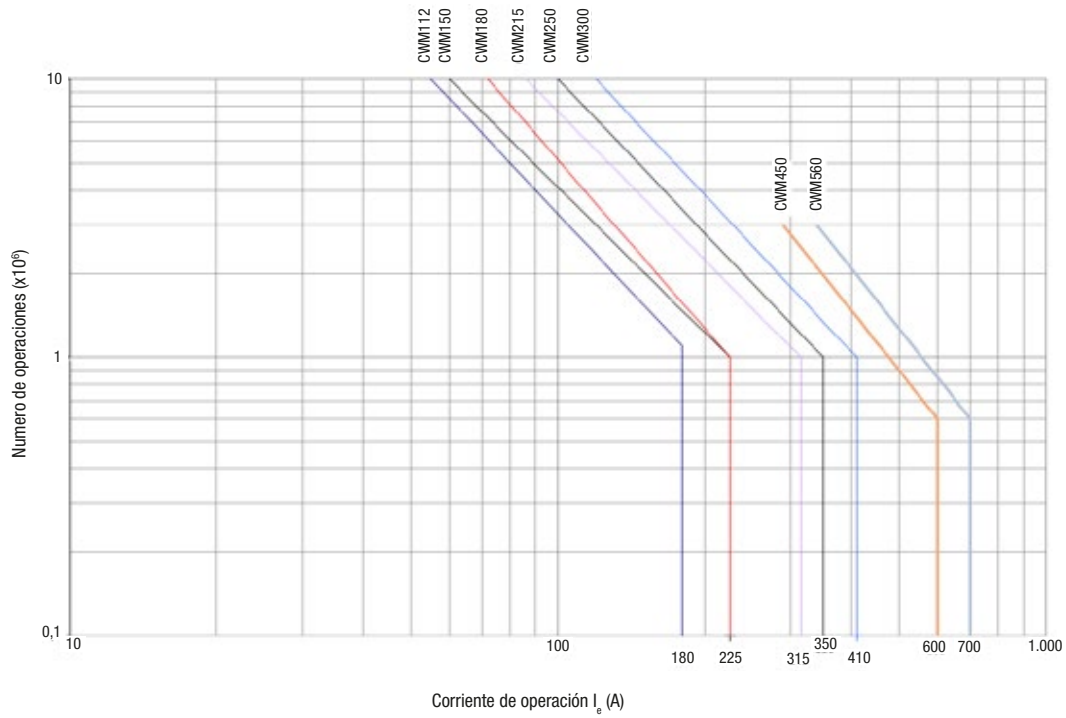

# Contadores CWM - Dimensiones (mm)

## CWM9, CWM12 y CWM18

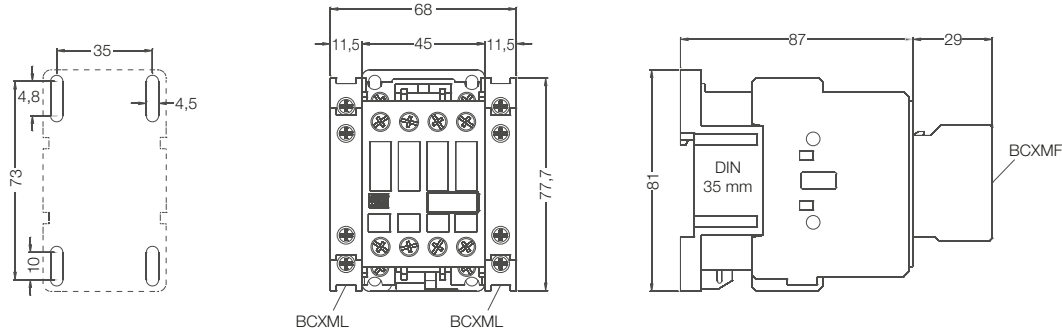

## CWM25

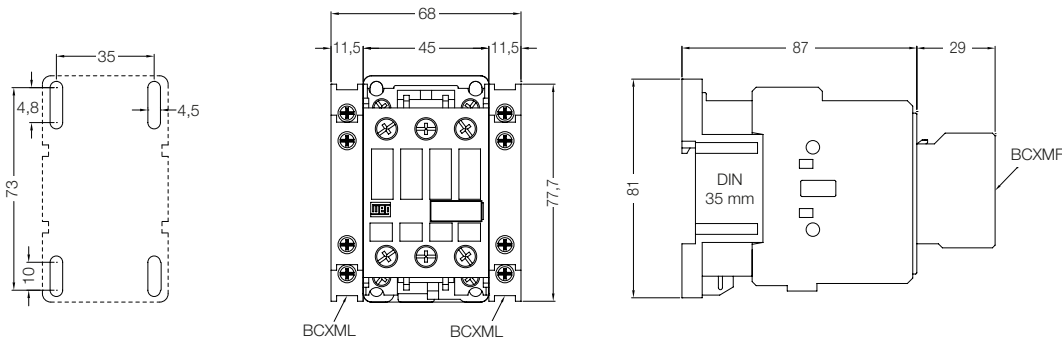

## CWM32 y CWM40

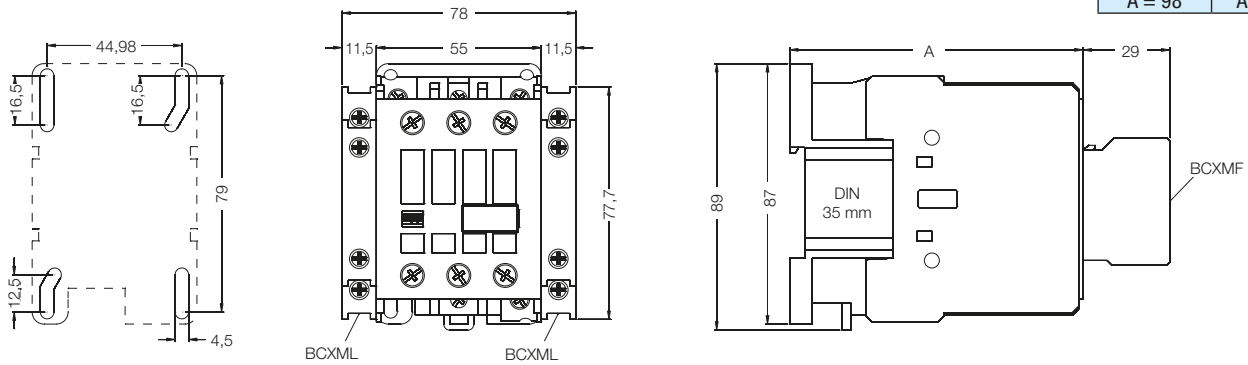

Bobina	
CA	CC
A = 98	A = 118

## CWM50, CWM65 y CWM80

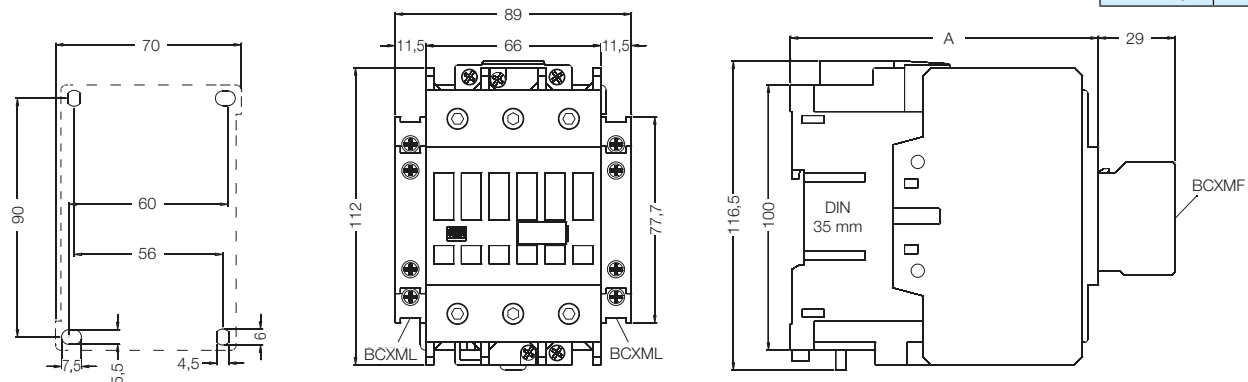

Bobina	
CA	CC
A = 116	A = 116

# Contadores CWM - Dimensiones (mm)

## CWM95 y CWM105

Bobina	
CA	CC
A = 126	A = 126

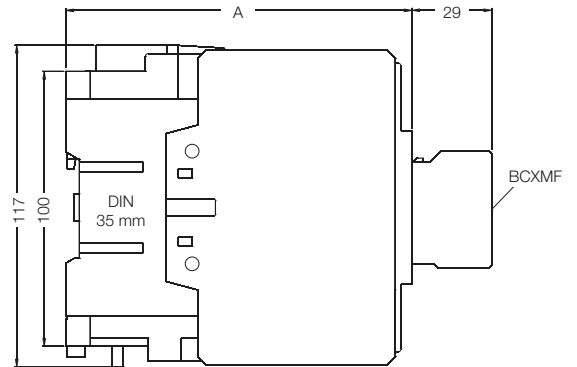
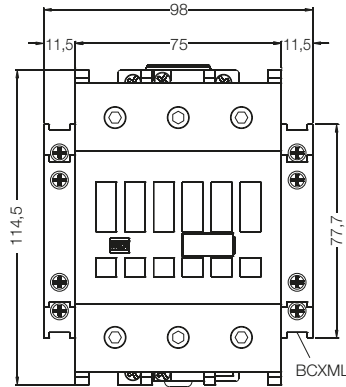
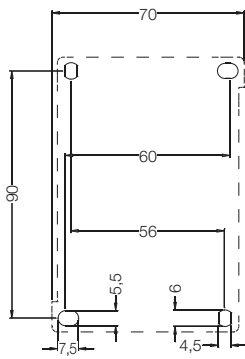

## CWM112 y CWM150

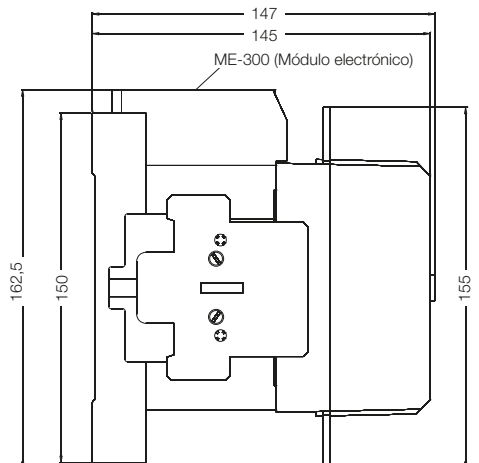
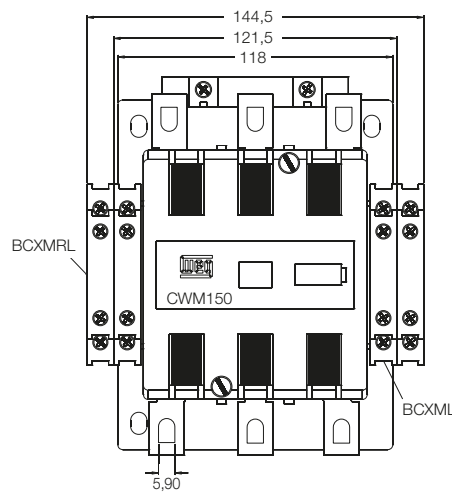
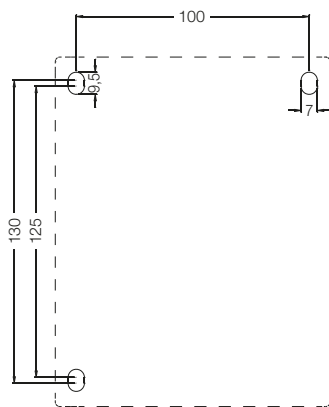

## CWM180 y CWM215

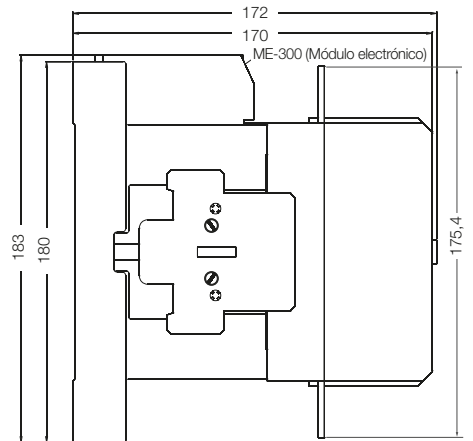
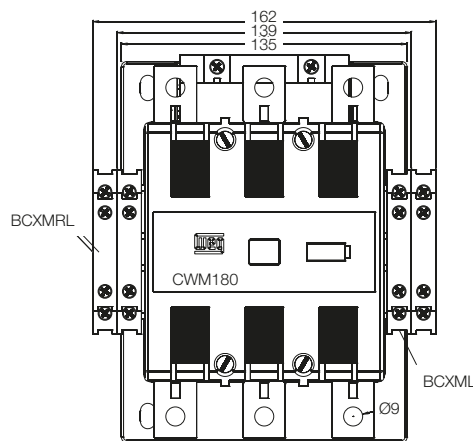
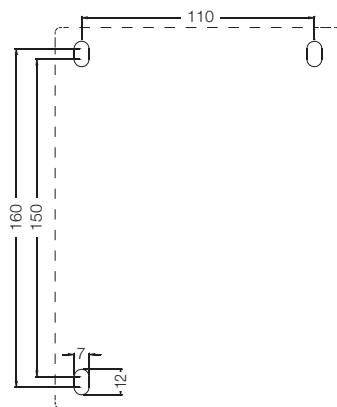

## Contadores CWM - Dimensiones (mm)

### CWM250 y CWM300

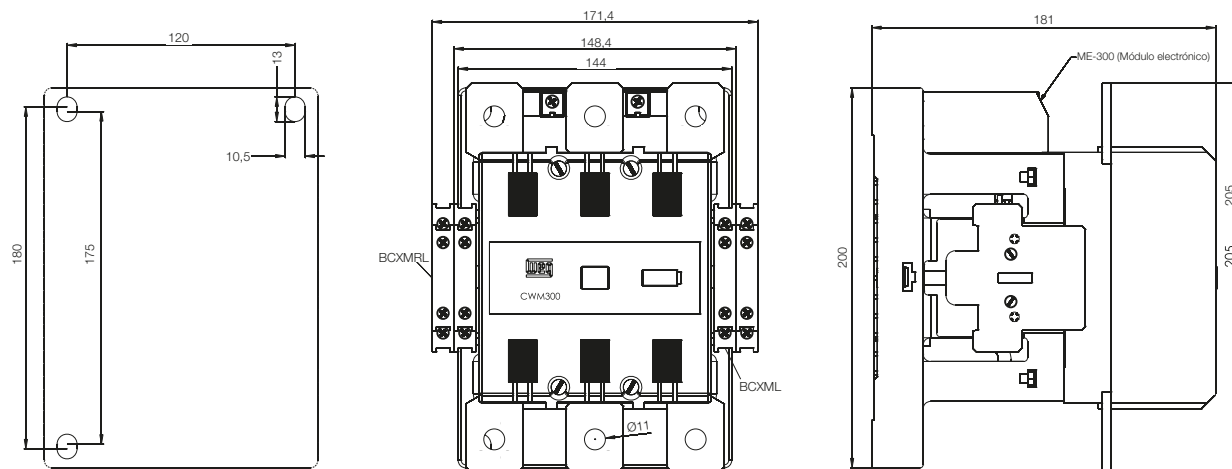

### CWM450 y CWM560

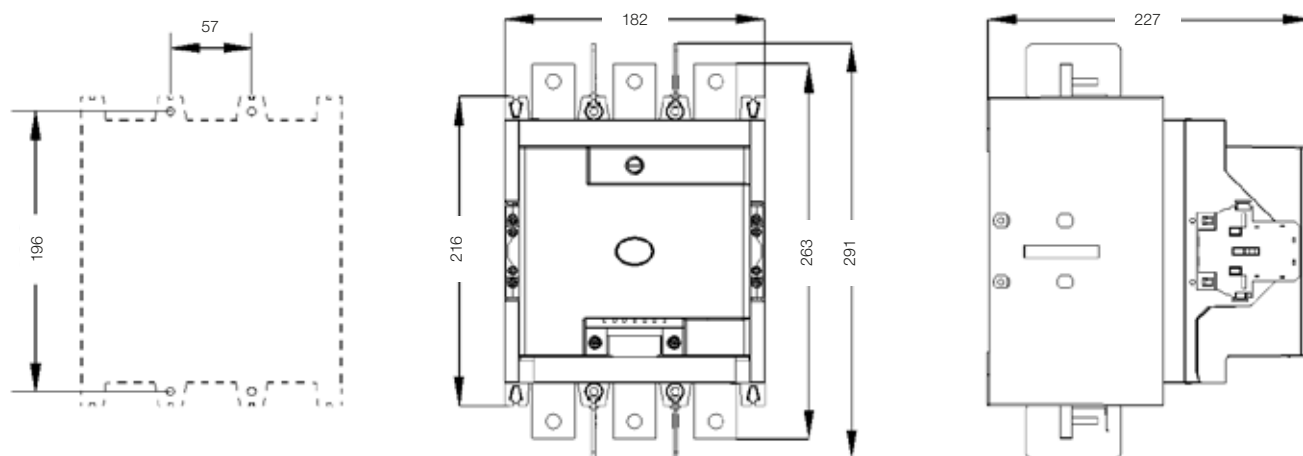

## Contadores CWM - Dimensiones (mm)

### BLIM9-105 y BLIM.02

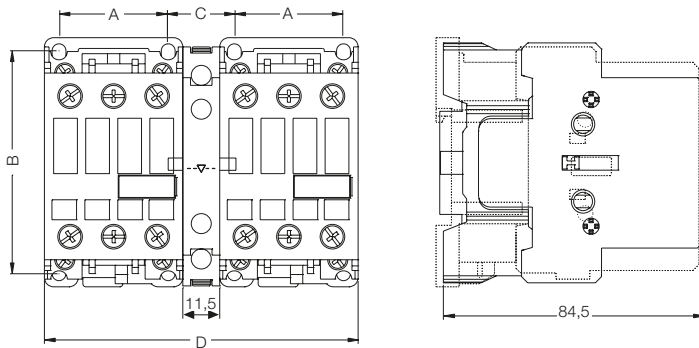

Referencia	A	B	C	D
CWM9...25	35	72,5	22	102
CWM32/40	45	79	22	122
CWM50...80	57	90	21	144
CWM95/105	57	90	29,8	153

### BLIM112-300

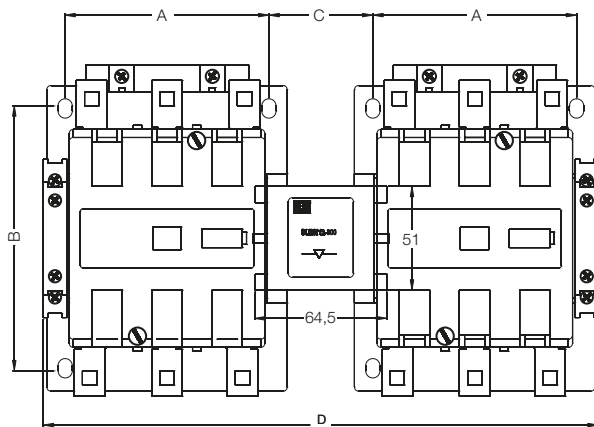

Referencia	A	B	C	D
CWM112/150	100	130	51	272,5
CWM180/215	110	160	58,5	303,5
CWM250/300	120	180	57	325,4
CWM450/560	57	196	175	414



## Contadores CWM - Dimensiones (mm)

### BMP CWM112...300, BMP CWM560

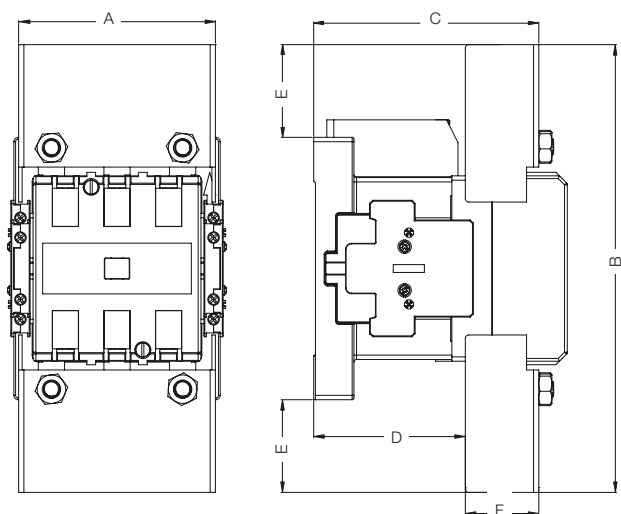

	BMP CWM150 + CWM112/150	BMP CWM180 + CWM180/215	BMP CWM300 + CWM250/300	BMP CWM560 + CWM450/560
A	112,5	127,5	148,5	180
B	256	290,4	320,8	457
C	128	137,7	146	101,3
D	86	90,7	84	20,3
E	53	55,2	60,5	120,9
F	42	47	62	81

### TB... + CWM112...300

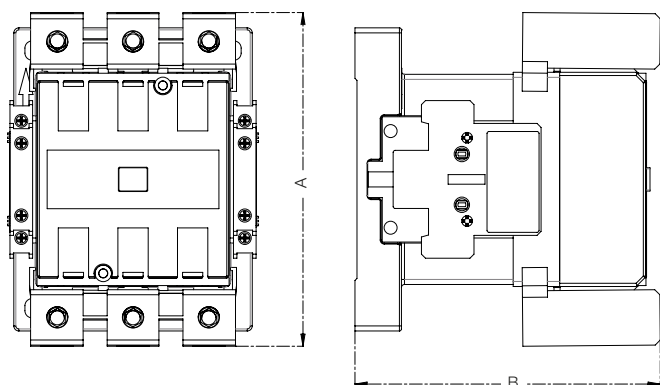

	TB150 + CWM112/150	TB180 + CWM180	TB300 + CWM250/300
A	167,6	190,3	218,6
B	151,1	176	193,8

### Posición de Montaje

#### CWM9...105, CWM450 y CWM560

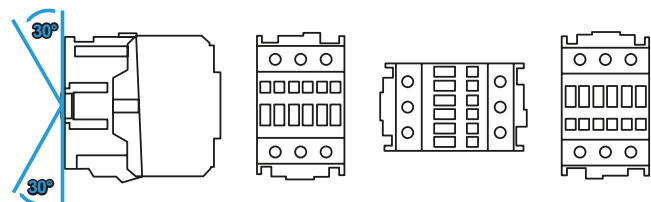

#### CWM112...300

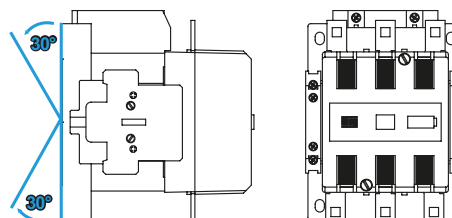

# Contactores CWM - Dimensiones (mm)

## CWM400 - 3 Polos

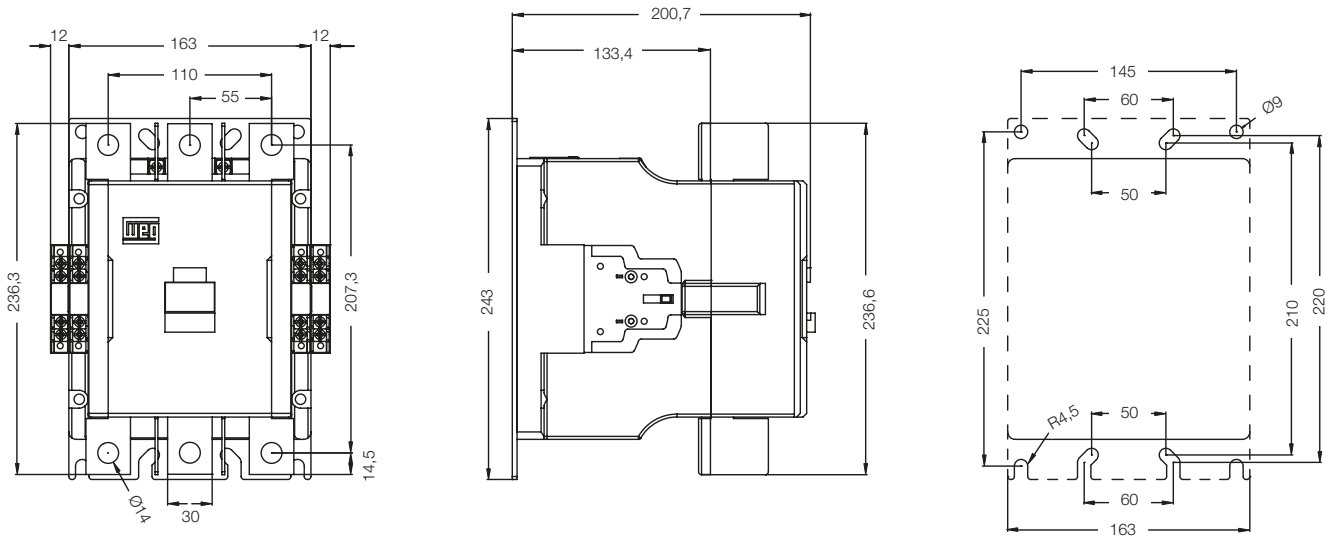

## CWM400 - 4 Polos

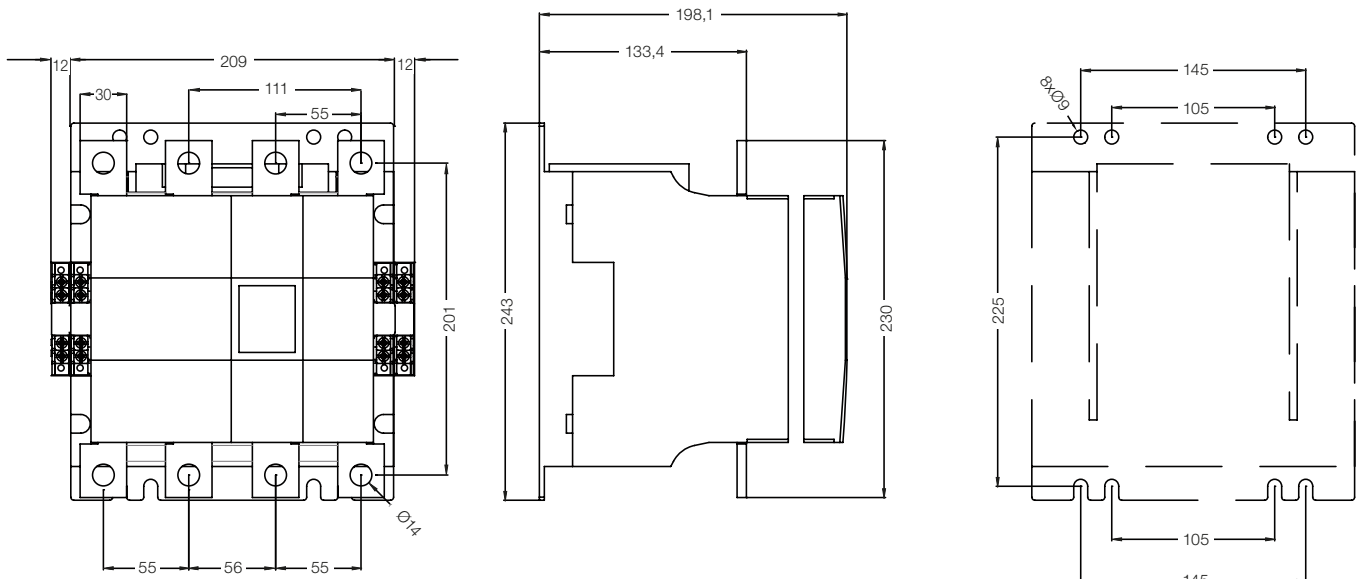

## Contadores CWM - Dimensiones (mm)

### CWM500, CWM630 y CWM800 - 3 Polos

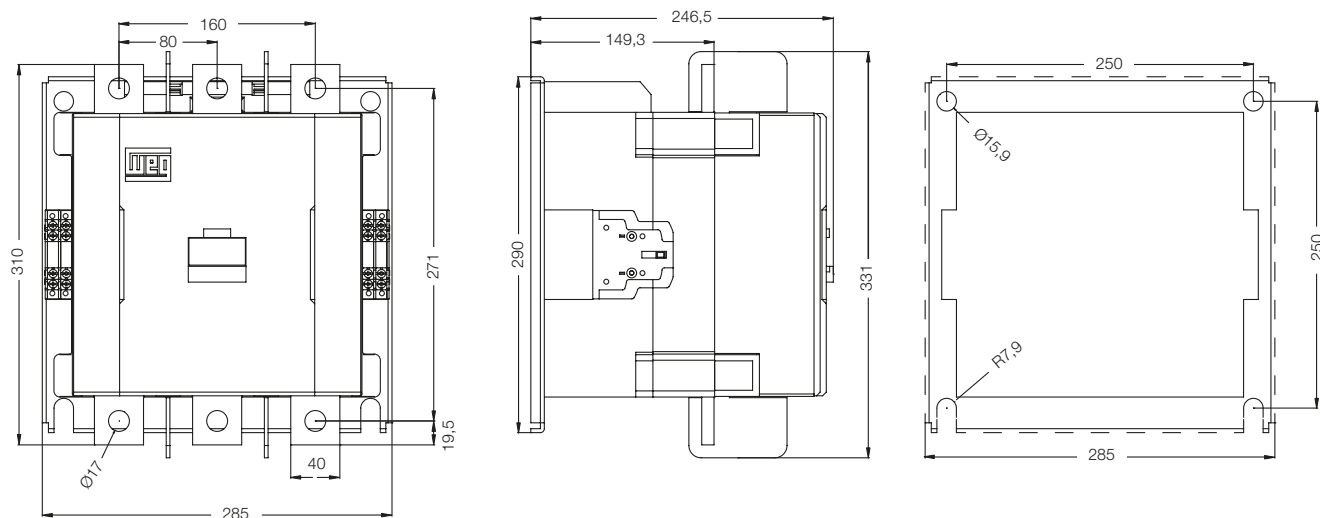

### CWM500, CWM630 y CWM800 - 4 Polos

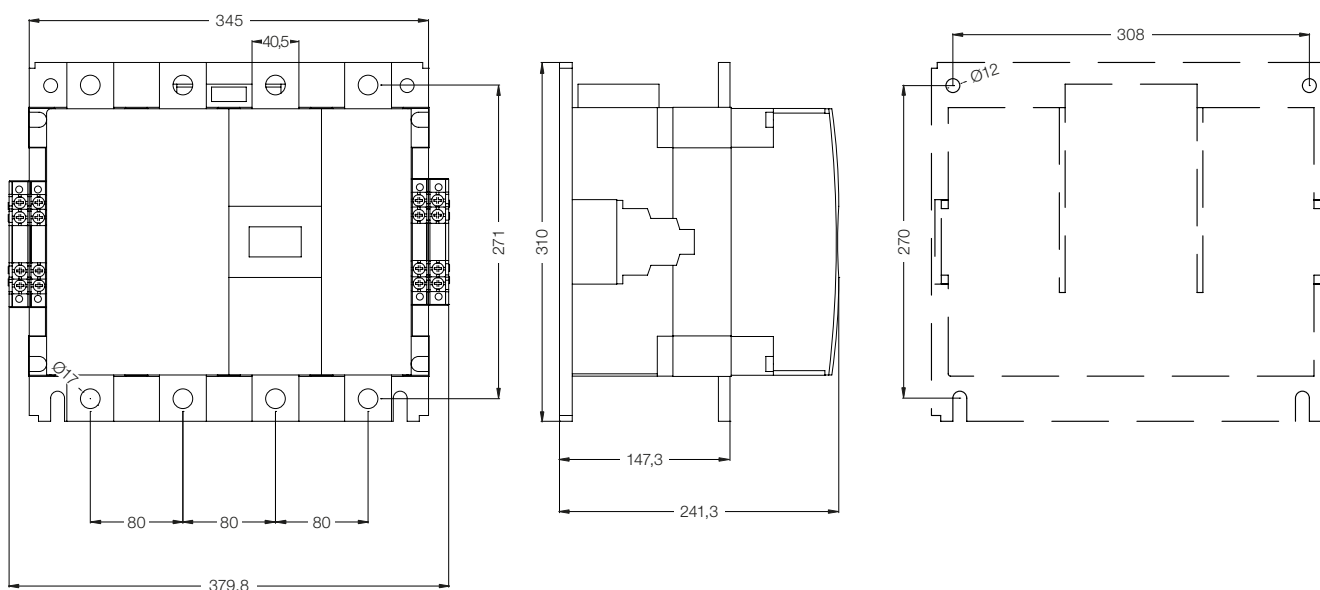



## Contadores CWM - Dimensiones (mm)

### BLIM CWM400

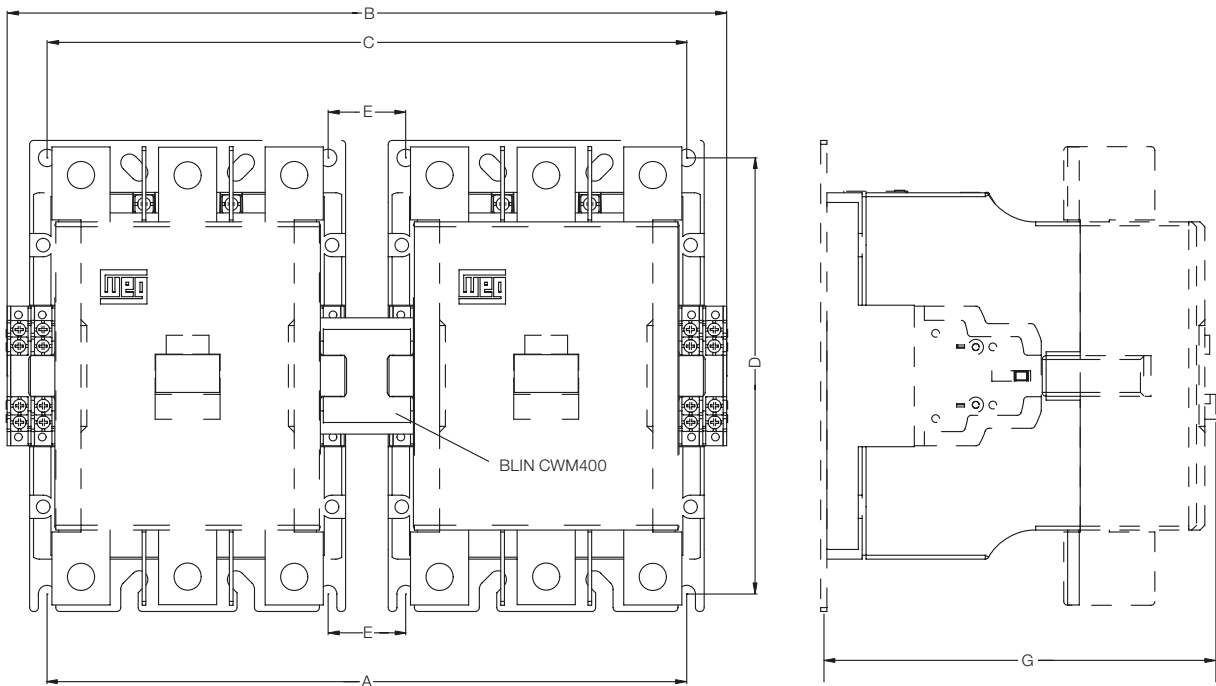

### BLIM CWM800

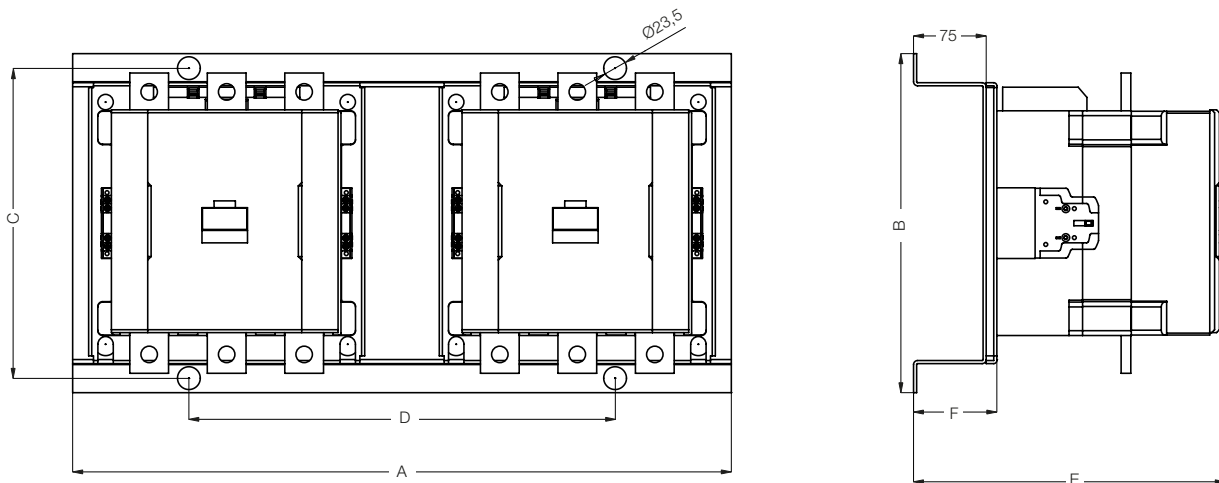

	BLIM CWM400 + CWM400	
	3 polos	4 polos
A	330	375
B	371,2	464
C	330	375
D	225	225
E	40	85
F	40	85
G	203,9	198,2

	BLIM CWM800 + CWM500 / 630 / 800	
	3 polos	4 polos
A	680	740
B	351	370
C	321	340
D	440	440
E	321	316,3
F	86	86
G	75	75

## Contadores CWM - Dimensiones (mm)

### BMP CWM400 / 500 / 630 / 800

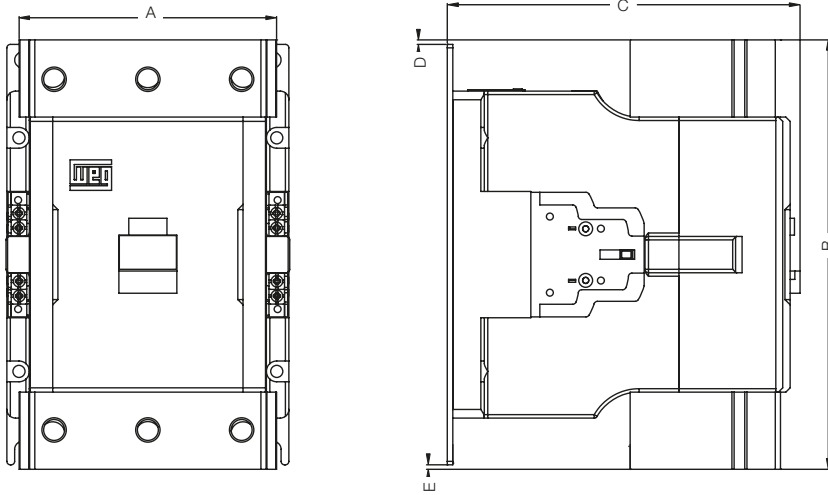

	BMP CWM400 + CWM400		BMP CWM800 + CWM500 / 630 / 800	
	3 polos	4 polos	3 polos	4 polos
A	148,8	214	234	314
B	248,2	250,8	320,2	350,5
C	200,7	198,2	246,5	241,3
D	2,6	1,76	111,6	20,25
E	2,6	7,76	15,1	20,25

### BMJ CWM400 / 500 / 630 / 800

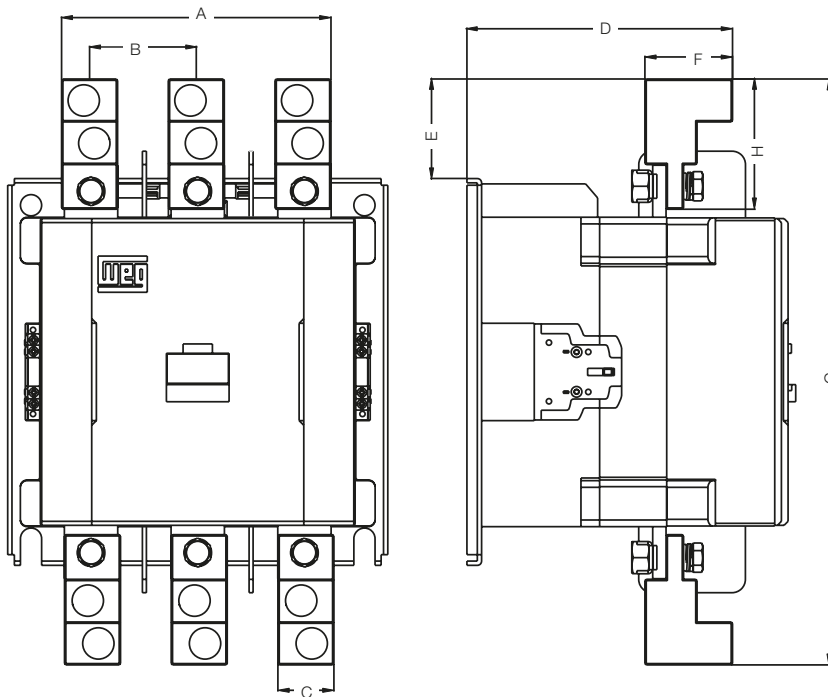

	BMJ CWM400 + CWM400	BMJ CWM800 + CWM500 / 630 / 800
	A	140,2
B	55	80
C	30,2	42
D	187,4	199,15
E	53,6	74,65
F	59,5	65,7
G	350,2	439,3

### Posición de Montaje

#### CWM400 / 500 / 630 / 800

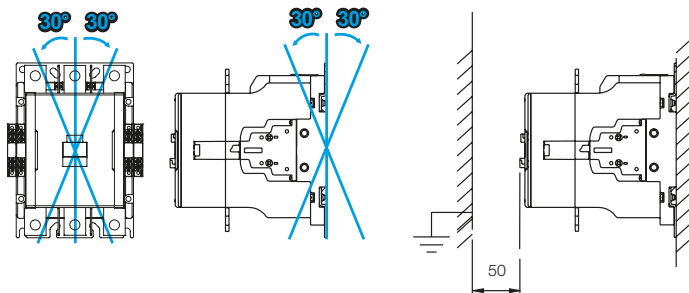



# La presencia global es esencial. Entender lo que usted precisa también.

## Presencia Global

Con más de 30.000 colaboradores en todo el mundo, somos uno de los mayores productores mundiales de motores eléctricos, equipos y sistemas electro-electrónicos. Estamos constantemente expandiendo nuestro portafolio de productos y servicios con conocimiento especializado y de mercado. Creamos soluciones integradas y personalizadas que van desde productos innovadores hasta asistencia postventa completa.

Con el *know-how* de WEG, los **Contactores - Línea CWM** son la elección adecuada para su aplicación y su negocio, con seguridad, eficiencia y confiabilidad.

 **Disponibilidad** es contar con una red global de servicios

 **Alianza** es crear soluciones que satisfagan sus necesidades

 **Competitividad** es unir tecnología e innovación

## Conozca

Productos de alto desempeño y confiabilidad para mejorar su proceso productivo.

Excelencia es desarrollar soluciones que aumentan la productividad de nuestros clientes, con una línea completa para automatización industrial.



Acceda a: [www.weg.net](http://www.weg.net)

 [youtube.com/wegvideos](https://youtube.com/wegvideos)

Para las operaciones  
WEG en todo el mundo  
visite nuestro sitio web



[www.weg.net](http://www.weg.net)



AUTOMATIZACIÓN

 +55 47 3276.4000

 [automacao@weg.net](mailto:automacao@weg.net)

 Jaraguá do Sul - SC - Brasil

Cod: 50070162 | Rev: 06 | Fecha (m/a): 12/2020.

Los valores demostrados pueden ser cambiados sin aviso previo.  
La información contenida son valores de referencia.