

Description



These switches are used on machines where the hazardous conditions remain for a while, even after the machines have been switched off, for example because of mechanical inertia of pulleys, saw disks, parts under pressure or with high temperatures. Thus, the switches can also be used if individual guards are only to be opened under certain conditions.

The versions with solenoid actuated NC contacts are considered interlocks with locking in accordance with ISO 14119, and the product's label is marked with the symbol shown.



Head and release devices with variable orientation

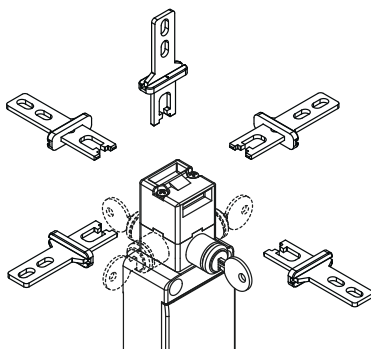

The head can be quickly turned to each of the four sides of the switch by unfastening the two fastening screws.

The auxiliary key release device can be rotated in 90° steps as well. This enables the switch to assume 32 different configurations.

Wide-ranging actuator travel

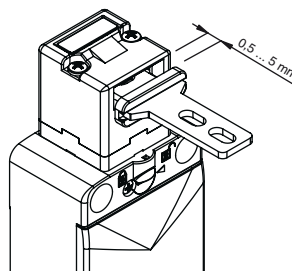

The actuation head of this switch features a wide range of travel. In this way the guard can oscillate along the direction of insertion (4.5 mm) without causing unwanted machine shutdowns. This wide range of travel is available in all actuators in order to ensure maximum device reliability.

Holding force of the locked actuator

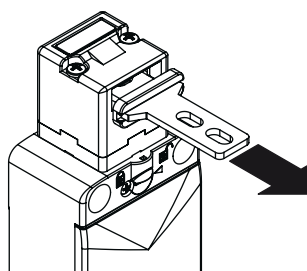

The strong interlocking system guarantees a maximum actuator holding force of $F_{1max} = 1100 \text{ N}$ (head 96).

Safety screws for actuators

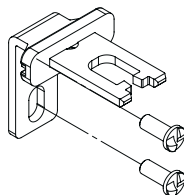

As required by EN ISO 14119, the actuator must be fixed immovably to the door frame. Pan head safety screws with one-way fitting are available for this purpose. With this screw type, the actuators cannot be removed or tampered by using common tools. See accessories on page 308.

Protection degree IP67

IP67

These devices are designed to be used in the toughest environmental conditions and they pass the IP67 immersion test acc. to EN 60529.

They can therefore be used in all environments where maximum protection degree of the housing is required.

Contact block

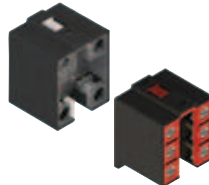

Contact blocks with captive screws, finger protection, twin bridge contacts and double interruption for higher contact reliability. Versions with gold-plated contacts available. Available in multiple variants with actuation by actuator or by solenoid.

Turnable key release with lock

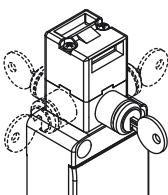

The auxiliary key release device is used to allow the maintenance or the entry into the machinery to authorized personnel only. Turning the key corresponds to actuating the solenoid: the actuator is released. The device can be turned, thereby enabling installation of the safety switch in the machine while the release device remains accessible on the outside of the guard. In this way, the switch is better protected against possible tampering and the external side/surface of the machinery remains smooth.

Circuit board for monitoring the current consumption of the solenoid.

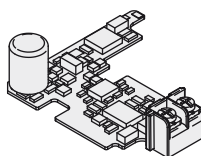

This technical solution resolves the problems that may derive from unstable power supply (machine distance from main transformers, voltage variation between night/day hours), allowing also a low solenoid power consumption and consequently enlarging the working temperature range of the switch.



Laser engraving



All FS series switches are permanently marked with a special laser system. As a result, the marking remains legible even under extreme operating conditions. Thanks to this system that does not use labels, the loss of plate data is prevented and a greater resistance of the marking is achieved over time.

Holding force of the unlocked actuator

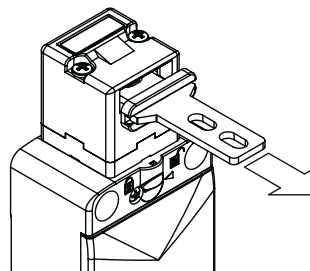

The inside of each switch features a device which holds the actuator in its closed position. Ideal for all those applications where several doors are unlocked simultaneously, but only one is actually opened. The device keeps all the unlocked doors in their position with a retaining force of 30 N~, stopping any vibrations or gusts of wind from opening them.

Two operating principles

D or E

The safety switches with solenoid offer two different operating principles for the actuator locking:

Operating principle D: locked actuator with de-energised solenoid. The actuator is released by applying the power supply to the solenoid.

Operating principle E: locked actuator with energised solenoid. The actuator is released by switching off the power supply to the solenoid. This version should only be used under certain conditions, since a power failure at the system will result in the immediate opening of the guard.

Sealable auxiliary release device



Switches with locked actuator with deactivated solenoid (function principle D) are equipped with an auxiliary release device for the solenoid to simplify installation of the switch and to facilitate entry into the danger zone in the event of a power failure. The auxiliary release device acts on the switch exactly as if the solenoid was energised. As a result, it also actuates the electrical contacts. Can only be actuated with a couple of tools, this ensures adequate resistance to tampering. If required it can be sealed by means of the hole provided.

Cable outputs

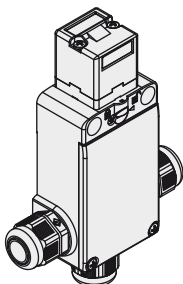

The switch is provided with three cable entries in different directions. This allows its application in series connections or in narrow places.

Gold-plated contacts

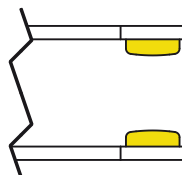

The contact blocks of these devices can be supplied gold-plated upon request. Ideal for applications with low voltages or currents; it ensures increased contact reliability. Available in two thicknesses (1 or 2.5 microns), it adapts perfectly to the various fields of application, ensuring a long endurance over time.

Selection diagram

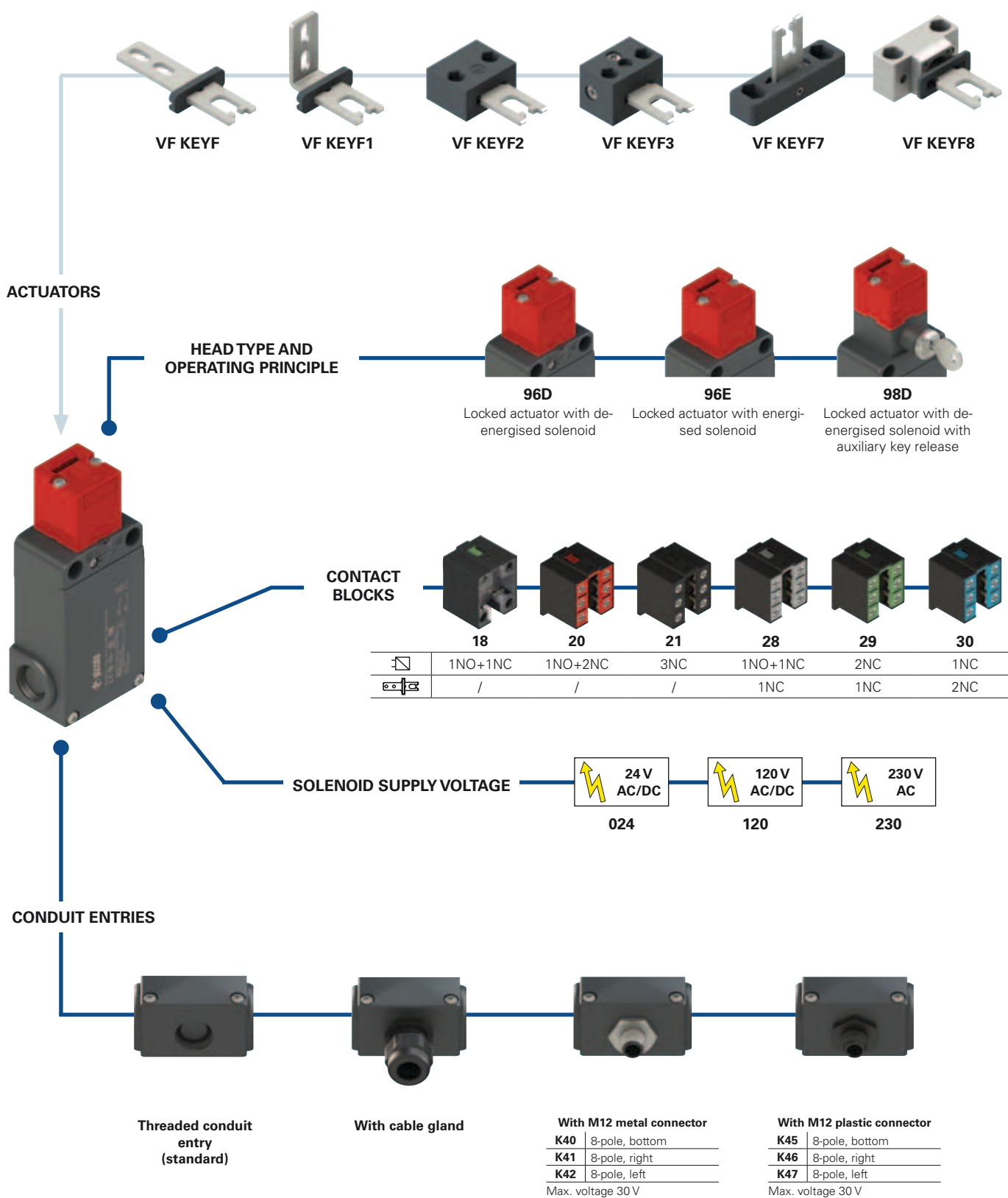

● product option
 → accessory sold separately



Code structure

Attention! The feasibility of a code number does not mean the effective availability of a product. Please contact our sales office.

article options options
FS 1896D024-F1GM2K40

Contact block		
	Contacts activated by the solenoid	Contacts activated by the actuator
18	1NO+1NC	/
20	1NO+2NC	/
21	3NC	/
28	1NO+1NC	1NC
29	2NC	1NC
30	1NC	2NC

Head type and operating principle	
96D	locked actuator with de-energised solenoid
96E	locked actuator with energised solenoid
98D	locked actuator with de-energised solenoid with auxiliary key release

Solenoid supply voltage	
024	24 Vac/dc (-10% ... +25%).
120	120 Vac/dc (-15% ... +20%)
230	230 Vac (-15% ... +10%)

Actuators	
	without actuator (standard)
F	straight actuator VF KEYF
F1	angled actuator VF KEYF1
F2	jointed actuator VF KEYF2
F3	jointed actuator adjustable in two directions VF KEYF3
F7	jointed actuator adjustable in one direction VF KEYF7
F8	universal actuator VF KEYF8

Pre-installed cable glands or connectors	
	no cable gland or connector (standard)
K23	cable gland for cables Ø 6 ... 12 mm
...
K40	M12 metal connector, 8-pole
...
K45	M12 plastic connector, 8-pole
...

For the complete list of possible combinations please contact our technical department.

Threaded conduit entry	
M2	M20x1.5 (standard)
	PG 13.5

Contact type	
	silver contacts (standard)
G	silver contacts with 1 µm gold coating
G1	silver contacts, 2.5 µm gold coating (not for contact blocks 20, 21, 28, 29, 30)



Main features

- Technopolymer housing, three conduit entries
- Protection degree IP67
- 6 contact blocks available
- 6 stainless steel actuators available
- 3 solenoid supply voltages available
- Versions with auxiliary release device or turnable lock
- Operation with energised or de-energised solenoid

Quality marks:



IMQ approval:	CA02.00792
UL approval:	E131787
CCC approval:	2007010305230011
EAC approval:	RU C-IT.A135.B.00454

Technical data

Housing

Housing made of glass fibre reinforced technopolymer, self-extinguishing, shock-proof and with double insulation:

Three knock-out threaded conduit entries:	M20x1.5 (standard)
Protection degree:	IP67 acc. to EN 60529 with cable gland of equal or higher protection degree

General data

For safety applications up to:	SIL 3 acc. to EN 62061 PL e acc. to EN ISO 13849-1
Interlock with mechanical lock, coded:	type 2 acc. to EN ISO 14119
Coding level:	low acc. to EN ISO 14119
Safety parameters:	
B _{10D} :	4,000,000 for NC contacts
Service life:	20 years
Ambient temperature:	-25°C ... +60°C
Max. actuation frequency:	600 operating cycles/hour
Mechanical endurance:	800,000 operating cycles
Max. actuation speed:	0.5 m/s
Min. actuation speed:	1 mm/s
Maximum force before breakage F _{1max} :	1100 N (head 96), 900 N (head 98) acc. to EN ISO 14119
Max. holding force F _{zh} :	846 N (head 96), 692 N (head 98) acc. to EN ISO 14119
Maximum clearance of locked actuator:	4.5 mm
Released actuator extraction force:	30 N
Tightening torques for installation:	see page 313-324

Cable cross section (flexible copper strands)

Contact blocks 20, 21, 28, 29, 30:	min. 1 x 0.34 mm ² (1 x AWG 22) max. 2 x 1.5 mm ² (2 x AWG 16)
Contact block 18:	min. 1 x 0.5 mm ² (1 x AWG 20) max. 2 x 2.5 mm ² (2 x AWG 14)

In compliance with standards:

IEC 60947-5-1, EN 60947-5-1, EN 60947-1, IEC 60204-1, EN 60204-1, EN ISO 14119, EN ISO 12100, IEC 60529, EN 60529, EN 61000-6-2, EN 61000-6-3, BG-GS-ET-15, UL 508, CSA 22.2 N. 14.

Approvals:

IEC 60947-5-1, UL 508, CSA 22.2 N. 14, GB14048.5-2001.

Compliance with the requirements of:

Machinery Directive 2006/42/EC and EMC Directive 2014/30/EU.

Positive contact opening in conformity with standards:

IEC 60947-5-1, EN 60947-5-1.

Solenoid

Duty cycle:	100% ED (continuous operation)
Solenoid inrush power:	20 VA 0.1 s (24 V) 18 VA 0,1 s (120 V) 18 VA 0,1 s (230 V)
Solenoid consumption:	4 VA
Average overall consumption:	10 VA
Solenoid protection 24 V:	fuse 500 mA, delayed
Solenoid protection 120 V:	fuse 315 mA, delayed
Solenoid protection 230 V:	fuse 160 mA, delayed

Notes: Calculate the power supply using the average overall consumption. Please consider the solenoid inrush power in order to avoid intervention of overload-protection in case of electronic power supply.

⚠ If not expressly indicated in this chapter, for correct installation and utilization of all articles see chapter utilization requirements from page 313 to page 324.

**Electrical data****Utilization category**

without connector	Thermal current (I_{th}):	10 A	Alternating current: AC15 (50÷60 Hz)			
	Rated insulation voltage (U_i):	500 Vac 600 Vdc 400 Vac 500 Vdc (contact blocks 20, 21, 28, 29, 30)	U_e (V)	250	400	500
	Rated impulse withstand voltage (U_{imp}):	6 kV 4 kV (contact blocks 20, 21, 28, 29, 30)	I_e (A)	6	4	1
	Conditional short circuit current: Protection against short circuits: Pollution degree:	1000 A acc. to EN 60947-5-1 type aM fuse 10 A 500 V 3	Direct current: DC13	U_e (V)	24	125
			I_e (A)	6	1.1	0.4

with M12 connector 8-pole	Thermal current (I_{th}):	2 A	Alternating current: AC15 (50÷60 Hz)		
	Rated insulation voltage (U_i):	30 Vac 36 Vdc	U_e (V)	24	
	Protection against short circuits: Pollution degree:	type gG fuse 2 A 500 V 3	Direct current: DC13	I_e (A)	2
			U_e (V)	24	
			I_e (A)	2	

Features approved by IMQ

Rated insulation voltage (U_i):	500 Vac 400 Vac (for contact blocks 20, 21, 28, 29, 30)
Conventional free air thermal current (I_{th}):	10 A
Protection against short circuits:	type aM fuse 10 A 500 V
Rated impulse withstand voltage (U_{imp}):	6 kV 4 kV (for contact blocks 20, 21, 28, 29, 30)
Protection degree of the housing:	IP67
MV terminals (screw terminals)	
Pollution degree:	3
Utilization category:	AC15
Operating voltage (U_e):	400 Vac (50 Hz)
Operating current (I_e):	3 A

Forms of the contact element: Zb, Y+Y+X, Y+Y+Y, Y+X+X
Positive opening contacts on contact blocks 18, 20, 21, 28, 29, 30

In compliance with standards: EN 60947-1, EN 60947-5-1+ A1:2009, fundamental requirements of the Low Voltage Directive 2014/35/EU.

Please contact our technical department for the list of approved products.

Features approved by UL

Utilization categories	Q300 (69 VA, 125-250 Vdc) A600 (720 VA, 120-600 Vac)
Housing features type 1, 4X "indoor use only"; 12, 13	
For all contact blocks use 60 or 75 °C copper (Cu) conductor, rigid or flexible, wire size 12, 14 AWG. Tightening torque for terminal screws of 7.1 lb in (0.8 Nm).	

In compliance with standard: UL 508, CSA 22.2 N. 14

Please contact our technical department for the list of approved products.



Operating principle

The operating principle of these safety switches allows three different operating states:

state A: with inserted and locked actuator

state B: with inserted but not locked actuator

state C: with extracted actuator

All or some of these states can be monitored by means of electrical contacts with positive opening by selecting the appropriate contact blocks. In detail, contact blocks that have electric contacts marked with the symbol of the solenoid () are switched in the transition between the state A and state B, while the electric contacts marked with the symbol of the actuator () are switched between state B and state C.

It is also possible to choose between two operating principles for the actuator locking:

- **Operating principle D**: locked actuator with de-energised solenoid. The actuator is released by applying the power supply to the solenoid (see example of the operating phases).
- **Operating principle E**: locked actuator with energised solenoid. The actuator is released by switching off the power supply to the solenoid. This version should only be used under certain conditions, since a power failure at the system will result in the immediate opening of the guard.

Example: operating phases with FS 2896D024-F1 (switch with operating principle D)

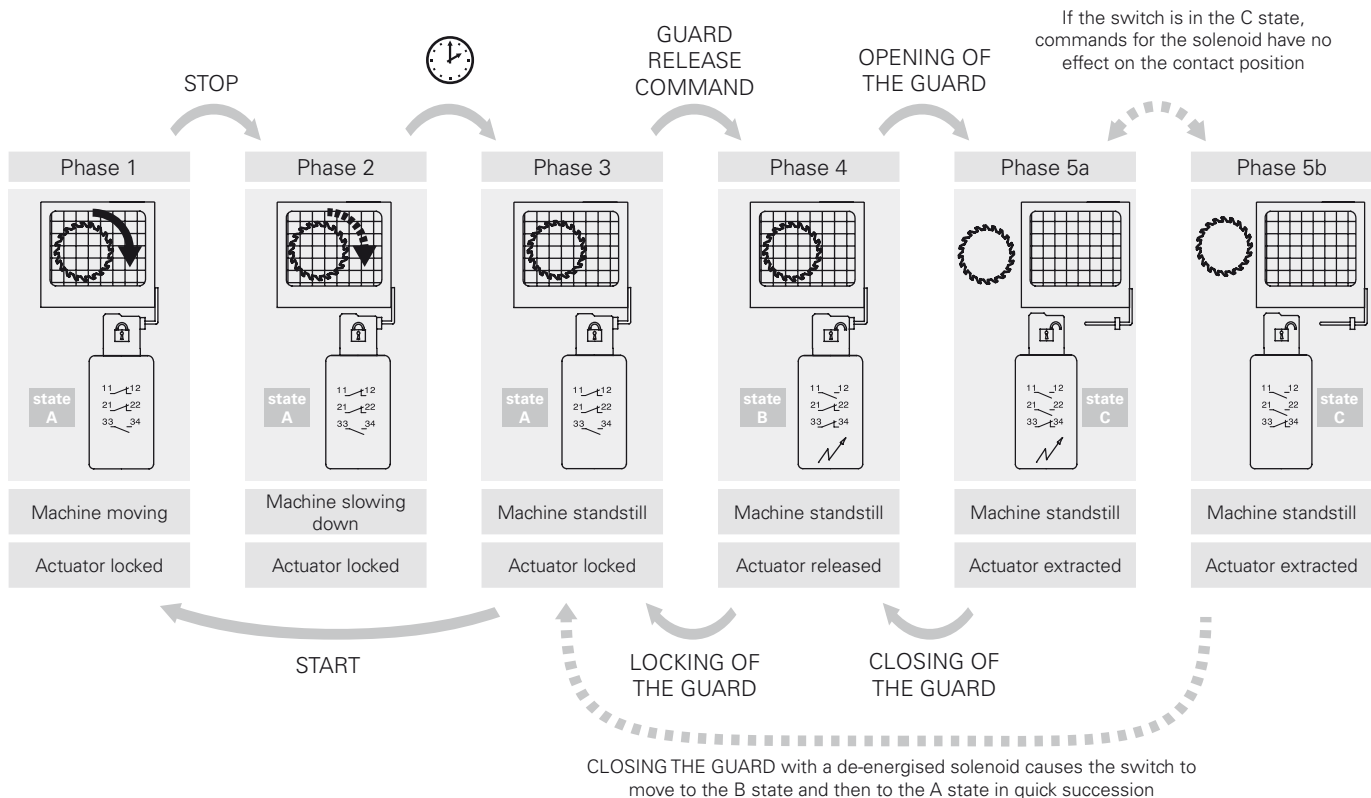

Installation of two or more switches connected to the same power supply

24 V AC/DC versions only

- This operation is intended to reduce the effects of the combined solenoid inrush currents on the power supply and should only be executed if necessary and with great care.
- Switch off the power supply.
- Open the switch cover.
- Loosen the two screws that secure the black plastic protective cover of the solenoid to the switch body and remove the plastic protective cover.
- Use a pin to set the selector switch so that each switch has a different combination (see figure at the side). If more than two switches are installed, repeat the combinations for any next set of two switches.
- Reposition the black plastic protective cover and tighten the two screws with a torque of 0.8 Nm.

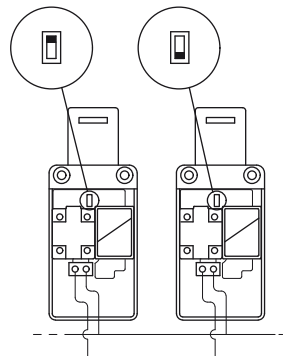



Contact positions related to switch states

Operating state	Operating principle D locked actuator with de-energised solenoid			Operating principle E locked actuator with energised solenoid		
	state A	state B	state C	state A	state B	state C
Actuator	Inserted and locked	Inserted and released	Extracted	Inserted and locked	Inserted and released	Extracted
Solenoid	De-energised	Energised	-	Energised	De-energised	-

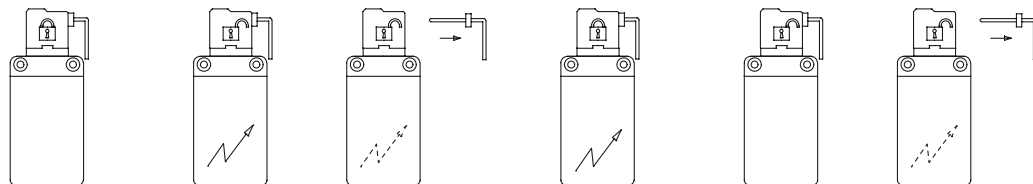

FS 18 1NC+1NO controlled by the solenoid		11 — 12	11 — 12	11 — 12	11 — 12	11 — 12	11 — 12
		23 — 24	23 — 24	23 — 24	23 — 24	23 — 24	23 — 24
FS 20 2NC+1NO controlled by the solenoid		11 — 12	11 — 12	11 — 12	11 — 12	11 — 12	11 — 12
		21 — 22	21 — 22	21 — 22	21 — 22	21 — 22	21 — 22
		33 — 34	33 — 34	33 — 34	33 — 34	33 — 34	33 — 34
FS 21 3NC controlled by the solenoid		11 — 12	11 — 12	11 — 12	11 — 12	11 — 12	11 — 12
		21 — 22	21 — 22	21 — 22	21 — 22	21 — 22	21 — 22
		31 — 32	31 — 32	31 — 32	31 — 32	31 — 32	31 — 32
FS 28 1NO+1NC controlled by the solenoid 1NC controlled by the actuator		11 — 12	11 — 12	11 — 12	11 — 12	11 — 12	11 — 12
		21 — 22	21 — 22	21 — 22	21 — 22	21 — 22	21 — 22
		33 — 34	33 — 34	33 — 34	33 — 34	33 — 34	33 — 34
FS 29 2NC controlled by the solenoid 1NC controlled by the actuator		11 — 12	11 — 12	11 — 12	11 — 12	11 — 12	11 — 12
		21 — 22	21 — 22	21 — 22	21 — 22	21 — 22	21 — 22
		31 — 32	31 — 32	31 — 32	31 — 32	31 — 32	31 — 32
FS 30 1NC controlled by the solenoid 2NC controlled by the actuator		11 — 12	11 — 12	11 — 12	11 — 12	11 — 12	11 — 12
		21 — 22	21 — 22	21 — 22	21 — 22	21 — 22	21 — 22
		31 — 32	31 — 32	31 — 32	31 — 32	31 — 32	31 — 32

Limits of use

Do not use where dust and dirt may penetrate in any way into the head and deposit there. Especially not where powder, shavings, concrete or chemicals are sprayed. Adhere to the EN ISO 14119 requirements regarding low level of coding for interlocks. Do not use in environments with presence of explosive or flammable gas. In these case use ATEX products (see dedicated Pizzato catalogue).

Attention! These switches alone are not suitable for applications where operators may physically enter the dangerous area, because an eventual closing of the door behind them could restart the machine operation. In these cases the actuator entry locking device VF KB1 shown on page 111 must be used.

Dimensional drawings

All values in the drawings are in mm

Contact type:

L = slow action

	Operating principle D, with sealable auxiliary release device, without actuator	Operating principle E, without actuator	Operating principle D, with auxiliary key release, without actuator
18			
20			
21			
28			
29			
30			
Actuating force	30 N (40 N \ominus)	30 N (40 N \ominus)	30 N (40 N \ominus)

Legend: \ominus With positive opening according to EN 60947-5-1, L interlock with lock monitoring acc. to EN ISO 14119

How to read travel diagrams

All values in the diagrams are in mm

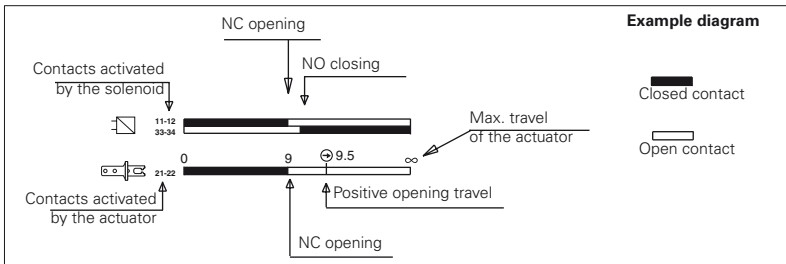

IMPORTANT:

The state of the NC contact refers to the switch with inserted actuator and locked lock. In **safety applications**, actuate the switch **at least up to the positive opening travel** shown in the travel diagrams with symbol \ominus . Actuate the switch **at least with the positive opening force**, reported in brackets below each article, next to the actuating force value.

Accessories

Article	Description
VF KB1	Actuator entry locking device
	Padlockable device to lock the actuator entry in order to prevent the accidental closing of the door behind operators while they are in the danger area. Hole diameter for padlocks: 9 mm.

Article	Description
VF KLA371	Set of two locking keys
	Extra copy of the locking keys to be purchased if further keys are needed (standard supply: 2 units). The keys of all switches have the same code. Other codes on request.

Items with code on green background are stock items

Accessories See page 299

→ The 2D and 3D files are available at www.pizzato.com



Stainless steel actuators

All values in the drawings are in mm

IMPORTANT: These actuators can be used only with items of the FD, FP, FL, FC, and FS series (e.g. FS 1896D024-M2).
Low level of coding acc. to EN ISO 14119.

Article	Description
VF KEYF	Straight actuator

Article	Description
VF KEYF1	Angled actuator

Article	Description
VF KEYF2	Jointed actuator

The actuator can flex in four directions for applications where the door alignment is not precise.

Article	Description
VF KEYF3	Actuator adjustable in two directions

Actuator adjustable in two directions for doors with reduced dimensions.

Article	Description
VF KEYF7	Actuator adjustable in one direction

Actuator adjustable in one direction for doors with reduced dimensions.

Article	Description
VF KEYF8	Universal actuator

Actuator adjustable in two dimensions for small doors; can be mounted in various positions.
The fixing block has two pairs of bore holes; it is provided for rotating the working plane of the actuator by 90°.

Accessories for sealing



Article	Description
VF FSPB-200	Pack of 200 lead seals
VF FSPB-10	Pack of 10 lead seals

Article	Description
VF FSFI-400	400 metre wire roll
VF FSFI-10	10 metre wire roll

Pliers, wire and lead seals are needed to seal the manual release device (head 96D).

Article	Description
VF FSPZ	Pliers without logo

Items with code on **green** background are stock items

Accessories See page 299

→ The 2D and 3D files are available at www.pizzato.com