

# Product data sheet

Specifications

SQUARE D

Green Premium™



Circuit breaker, PowerPact H, 30A, 3 pole, 600VAC, 25kA, lugs, thermal magnetic, 80%

HJL36030

Product availability : Stock - Normally stocked in distribution facility

**Price\* : 1,949.00 USD**

## Main

Range	PowerPact
Product name	PowerPact H
Product or Component Type	Circuit breaker
Device Application	Distribution

## Complementary

Line Rated Current	30 A
Number of Poles	3P
Protected poles description	3t
Control Type	Toggle
Breaking capacity code	J
Breaking capacity	100 kA 240 V AC 50/60 Hz UL 489 65 kA 480 V AC 50/60 Hz UL 489 25 kA 600 V AC 50/60 Hz UL 489 20 kA 250 V DC UL 489
[Ue] rated operational voltage	690 V AC 50/60 Hz IEC 60947-3
Network Frequency	50/60 Hz
[Ics] rated service breaking capacity	65 kA 220/240 V AC 50/60 Hz IEC 60947-2 35 kA 380/440/415 V AC 50/60 Hz IEC 60947-2 18 kA 500/525 V AC 50/60 Hz IEC 60947-2 20 kA 250 V DC IEC 60947-2 20 kA 500 V DC IEC 60947-2
[Uimp] rated impulse withstand voltage	8 kV IEC 60947-2
Trip unit technology	Thermal-magnetic
Magnetic tripping current	750 A
Magnetic hold current	350 A
Continuous current rating	80 %
[Ui] rated insulation voltage	750 V IEC 60947-2
Suitability for isolation	Yes IEC 60947-2
Utilisation category	Category A
AWG gauge	AWG 14...AWG 3/0 aluminium/copper terminal

\* Price is "List Price" and may be subject to a trade discount – check with your local distributor or retailer for actual price.

<b>Local signalling</b>	Switched off (OFF) 1 trip indicator green)
<b>Mounting mode</b>	Unit mount lug)
<b>Mounting Support</b>	Lug
<b>Electrical connection</b>	Lugs line Lugs load
<b>Terminal identifier</b>	AL150HD
<b>Tightening torque</b>	44.25 lbf.in (5 N.m) 0.00...0.01 in <sup>2</sup> (2.5...6 mm <sup>2</sup> ) (AWG 14...AWG 10) 123.91 lbf.in (14 N.m) 0.02...0.15 in <sup>2</sup> (10...95 mm <sup>2</sup> ) (AWG 8...AWG 3/0)
<b>Number of slots</b>	2 auxiliary switch OF plug-in) 1 alarm switch SD plug-in) 1 overcurrent trip switch SDE plug-in) 1 voltage release MN or MX plug-in)
<b>Power wire stripping length</b>	0.63 in (16 mm)
<b>Color</b>	Black
<b>Height</b>	6.42 in (163 mm)
<b>Width</b>	4.09 in (104 mm)
<b>Depth</b>	3.39 in (86 mm)
<b>Net Weight</b>	4.85 lb(US) (2.2 kg)
<b>Quantity per Set</b>	1
<b>Communication interface</b>	Modbus Ethernet

## Environment

<b>Quality labels</b>	CE
<b>Standards</b>	UL CSA NEMA NOM-003-SCFI-2000 IEC 60947-2
<b>Product certifications</b>	UL CSA NOM
<b>IP degree of protection</b>	Front cover IP40 IEC 60529
<b>Pollution degree</b>	3 IEC 60947-1
<b>Ambient Air Temperature for Operation</b>	28...158 °F (-2...70 °C)
<b>Ambient Air Temperature for Storage</b>	-58...185 °F (-50...85 °C)
<b>Operating altitude</b>	< 6561.68 ft (2000 m) without derating 5000 m with derating

## Ordering and shipping details

<b>Category</b>	01115-HG,HJ,JG,JJ UNIT MT BREAKER/SWITCH
<b>Discount Schedule</b>	DE2
<b>GTIN</b>	785901839323
<b>Nbr. of units in pkg.</b>	1
<b>Package weight(Lbs)</b>	4.08 lb(US) (1.85 kg)
<b>Returnability</b>	Yes
<b>Country of origin</b>	MX

## Packing Units

<b>Unit Type of Package 1</b>	PCE
-------------------------------	-----

Package 1 Height	5.71 in (14.5 cm)
Package 1 width	7.40 in (18.8 cm)
Package 1 Length	8.90 in (22.6 cm)

## Offer Sustainability

Sustainable offer status	Green Premium product
California proposition 65	WARNING: This product can expose you to chemicals including: DINP, which is known to the State of California to cause cancer, and DIDP, which is known to the State of California to cause birth defects or other reproductive harm. For more information go to <a href="http://www.P65Warnings.ca.gov">www.P65Warnings.ca.gov</a>
REACH Regulation	<a href="#">REACH Declaration</a>
EU RoHS Directive	Compliant <a href="#">EU RoHS Declaration</a>
Mercury free	Yes
RoHS exemption information	<a href="#">Yes</a>
China RoHS Regulation	<a href="#">China RoHS declaration</a> Product out of China RoHS scope. Substance declaration for your information.
Environmental Disclosure	<a href="#">Product Environmental Profile</a>
Circularity Profile	<a href="#">End of Life Information</a>
PVC free	Yes

## Contractual warranty

Warranty	18 months
----------	-----------

Dimensions

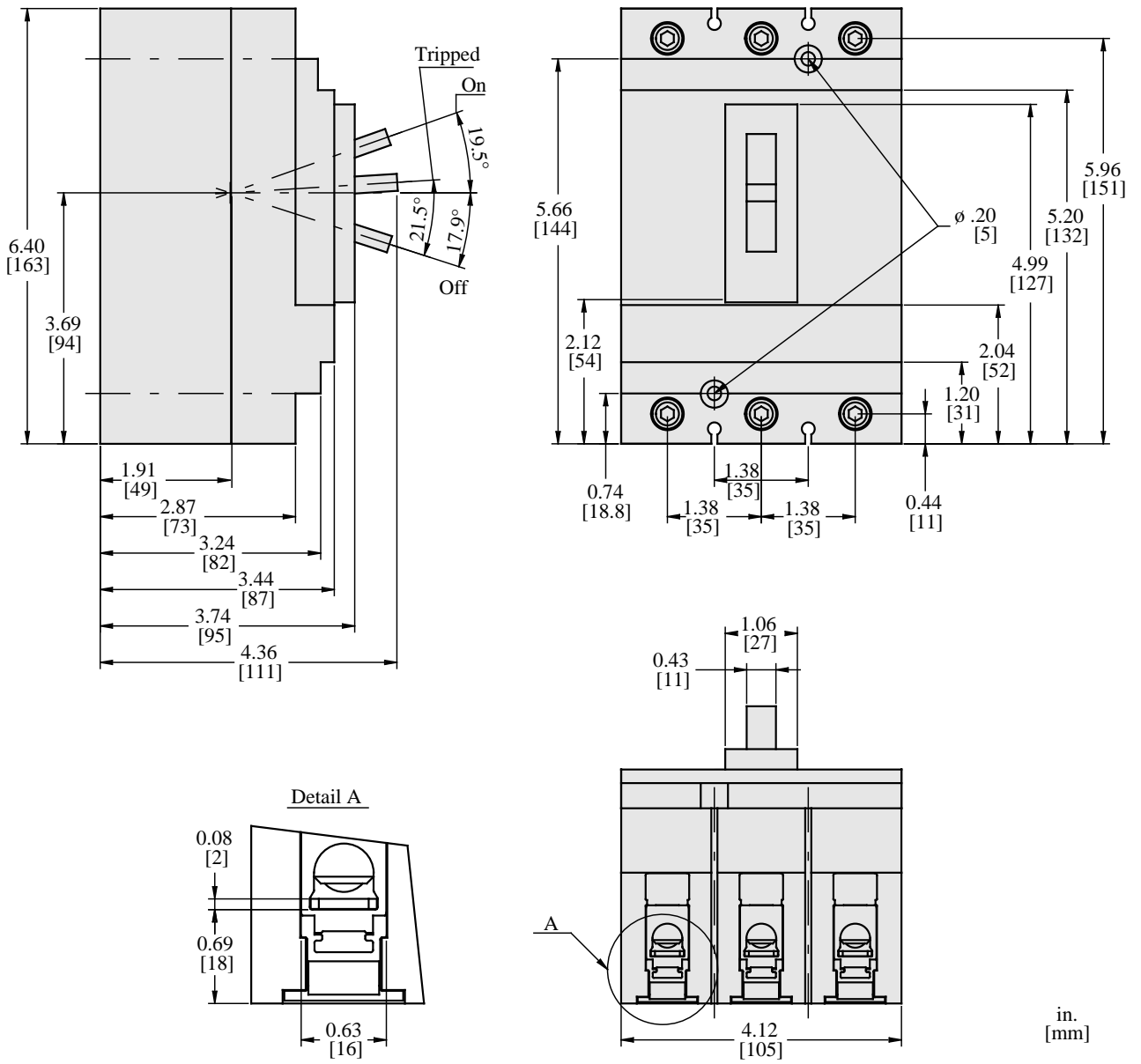

All dimensions are approximate. Also refer to technical drawings and documentation.