

Description



The microswitches of MK series have been designed to add new features to traditional and tested microswitches by Pizzato Elettrica.

The absolute new feature of this series is the enhanced and state-of-the-art trigger mechanism, whose design features are of higher quality in comparison to other solutions available on the market.

Thanks to the double and redundant execution, the electrical contact of the microswitch has been designed with a technology providing increased reliability, and is able to carry out switching operations with positive opening. Inside the housing of the microswitch it is possible to insert gaskets to protect the mechanism against fine dusts or liquids up to the protection degree IP65. Conductor fixing terminals are more practical, allowing for cables of different diameters to be fixed or the choice of different bends for the Faston contacts.

Contact reliability

In the following table a typical contact structure for a microswitch normally used in the industry (type A) is shown compared with the solution implemented by Pizzato Elettrica in the MK series microswitches: mobile contact with single interruption and double contacts (type B). As you can see from the table below, in the latter contact structure (type B) the contact resistance (R) is only half in comparison to the mobile contact with single interruption (type A), and presents a very low failure probability (fe) as well.

With a failure probability of x for a single switching operation, the failure probability for type A is $fe=x$, for type B $fe \approx x^2$. This means that if the probability of a switching failure is x in a given situation, e.g., 1×10^{-4} , (1 switching failure in 10,000), the result is as follows:

- for type A one failed commutation every 10,000.
- for type B one failed commutation every 100,000,000.

Type	Diagram	Description	Contact resistance R	Probability of errors fe
A Common micro-switch		mobile contact with single interruption	$R=R_c$	$fe=x$
B Pizzato's micro-switch MK series		mobile contact with single interruption and double contacts	$R=R_c/2$	$fe \approx x^2$

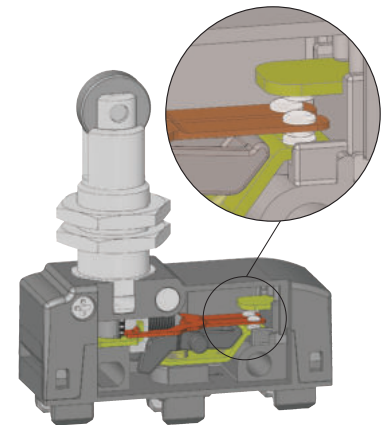

Extended temperature range

-40°C

The MK series includes versions with extended temperature range available upon request. Compared to the standard MK microswitches with temperature ranges from -25 C° to +85 C°, these special versions are suitable for environments with temperature ranges from -40 C° to +85 C°. They can therefore be installed inside cold stores, sterilizers or other equipment with very low ambient temperature. The special materials used to produce these versions retain their characteristics even under these conditions, thereby expanding the installation possibilities.

Microswitches for safety applications

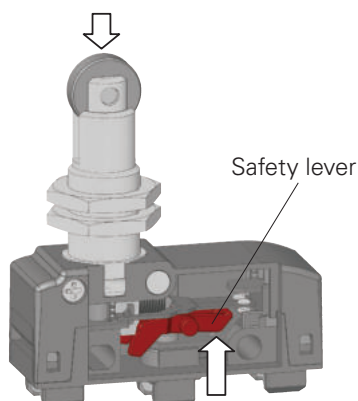

All microswitches showing the symbol \ominus besides the product code are with positive opening and therefore suitable for safety applications. These microswitches are provided with a rigid connection between the plunger and the NC contacts, which are forcibly actuated by a internal sturdy safety lever.

The positive opening has been designed in compliance with the standard EN 60947-5-1, Annex K. Therefore, these microswitches are suitable for safety applications.

Protection degree IP65

By installing microswitches MK ●●2●●● with terminal covers VF MKC●22 or terminal covers VF MKC●23, a microswitch fully protected against water and dust is obtained. Thanks to their special oil resistant rubber gaskets the protection degree IP65 is provided. For applications in very dirty environments there are also versions with integrated double gasket for the plunger (internal + external). e.g. MK ●●2●12 or MK ●●2●13.

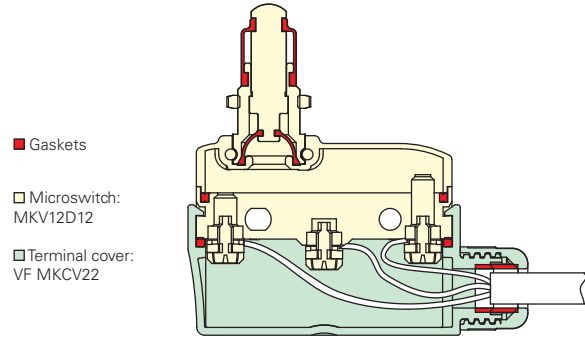

Clamping screw plates for cables of different diameters (MK V●)

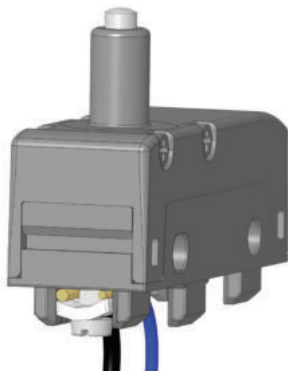

The clamping screw plates are provided with a particular "roofing tile" structure and are loosely coupled to the clamping screw. The design causes connection wires of different diameter to be pulled towards the screw when tightening the screw (see figure), preventing the wires from escaping towards the outside.

Terminal covers with side-by-side strain relief cable gland

The terminal covers are provided with strain relief cable gland and protection degree up to IP65. These are snap-on terminal covers and have reduced dimensions contained in the profile of the microswitch so that these can be installed on microswitches fixed side by side as well.

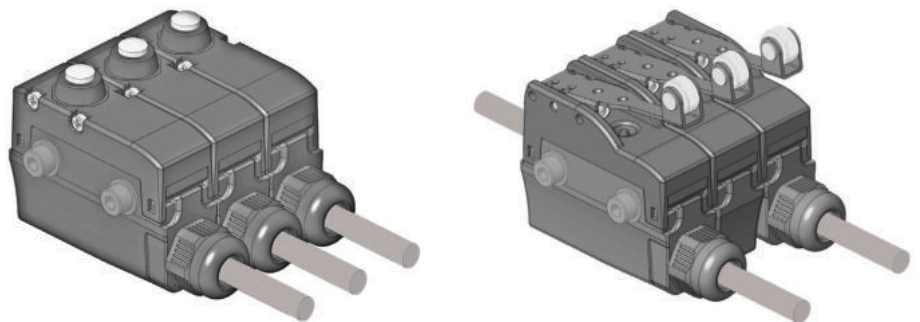

Actuators with variable orientation

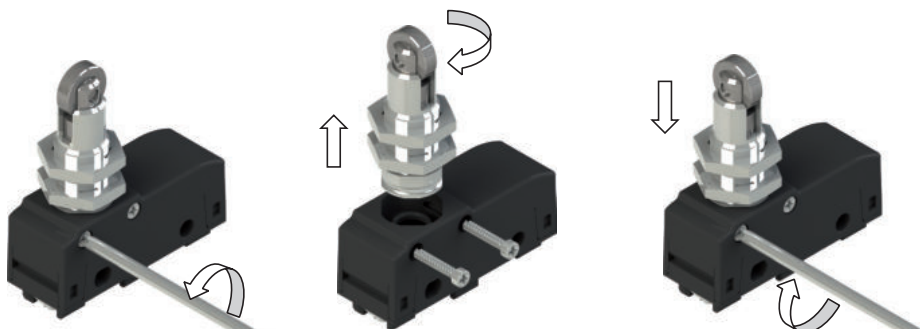

Thanks to the patented lateral fixing system, the roller of the microswitches MK ●●●15 and MK ●●17 can be now rotated in 90° steps.

The lateral fixing allows to disconnect the actuator from the switch body even when the actuator is already fixed to the support bracket. The flexibility of the product also allows for products to be unified in the warehouse for applications that require castors both in the longitudinal or transverse direction.

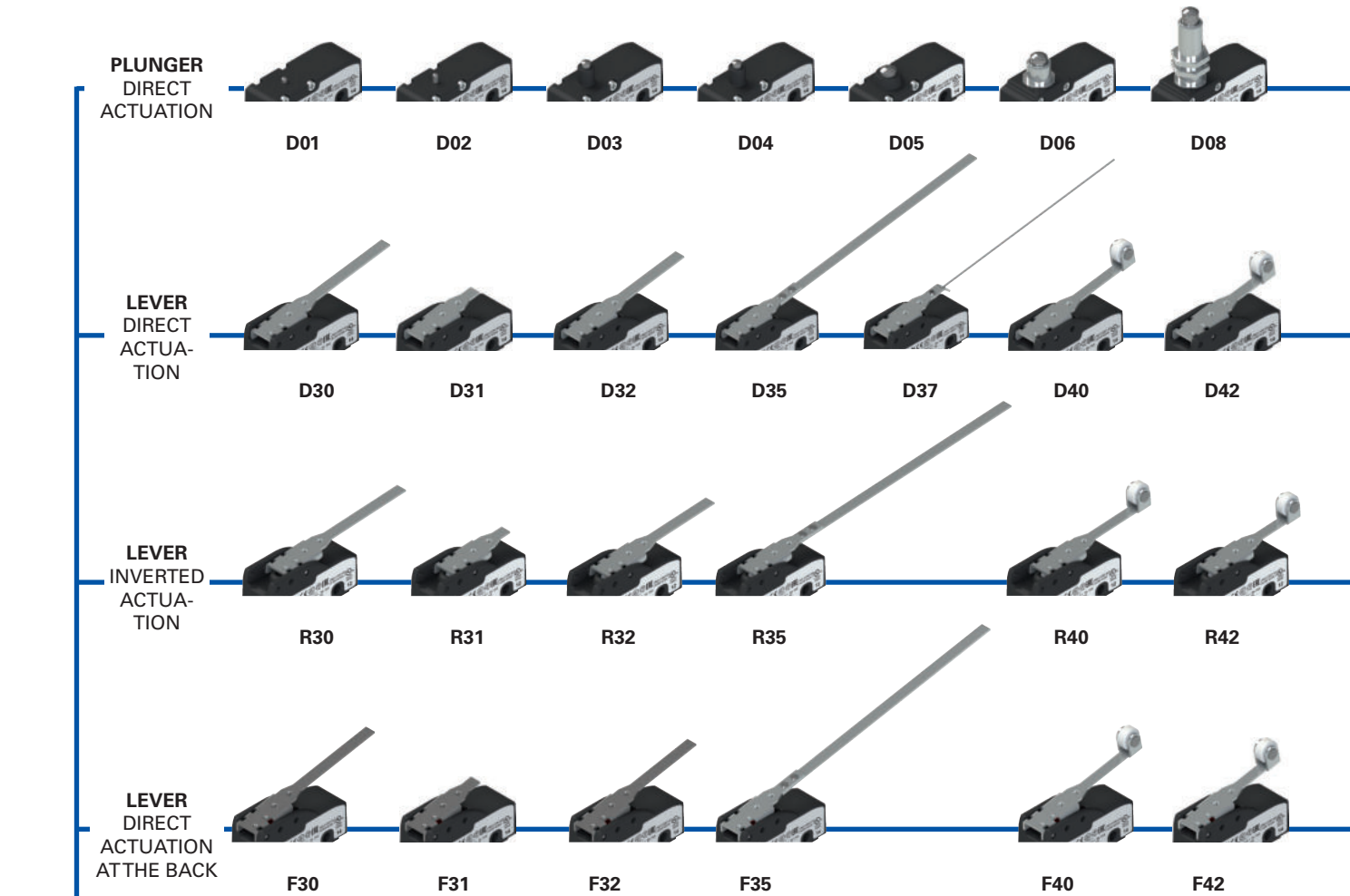

ACTUATORS

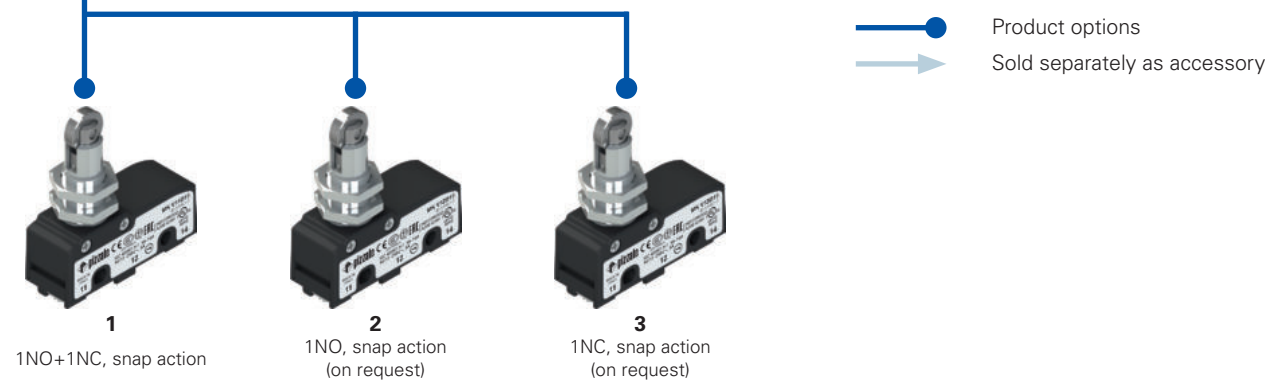

TERMINALS

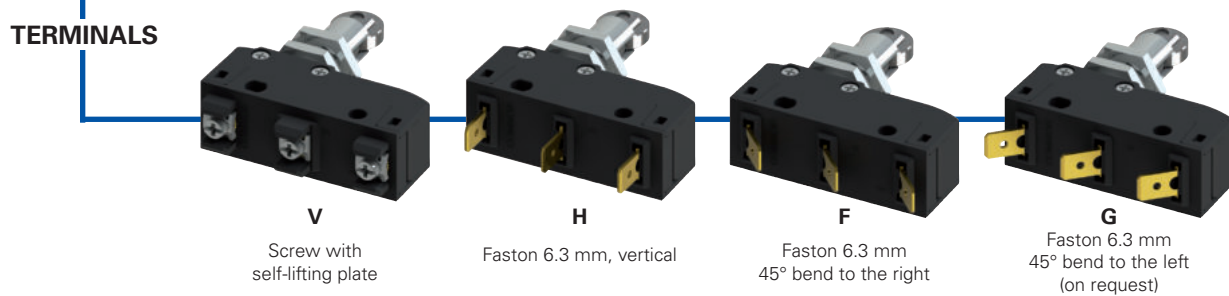

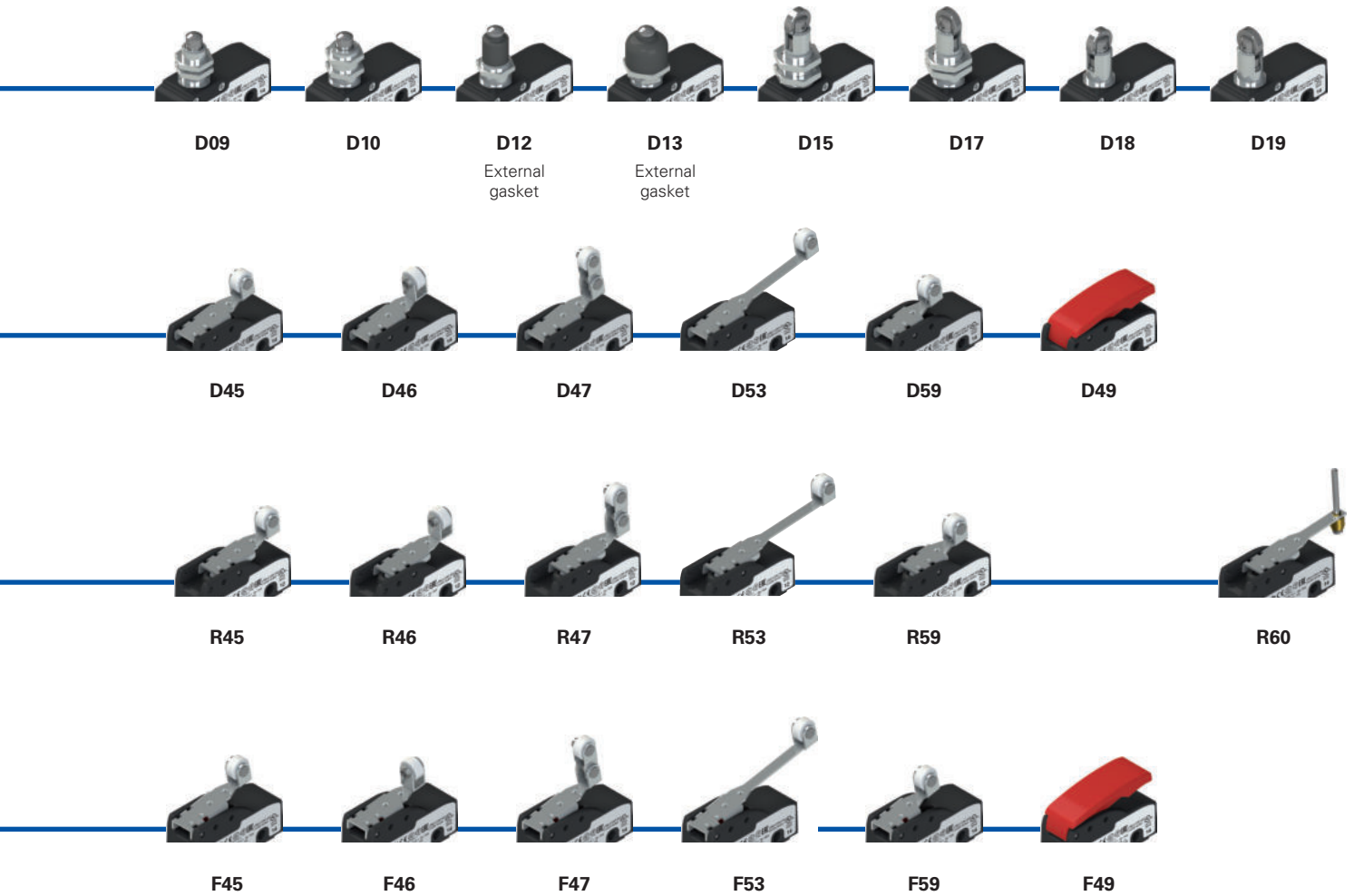
Code structure

Attention! The feasibility of a code number does not mean the effective availability of a product. Please contact our sales office.

article
options
MK V12D40-GR16T6

Terminal type	
V	screw with self-lifting plate
H	vertical faston
F	Faston, 45° bend to the right
G	Faston, 45° bend to the left (on request)

Contact block	
1	1NO+1NC, snap action, change-over
2	1NO, snap action (on request)
3	1NC, snap action (on request)

Maximum protection degree	
1	IP40 (with terminal cover)
2	IP65 (with terminal cover)

Type of actuation	
D	direct actuation
R	inverted actuation
F	direct actuation at the back

Ambient temperature	
	-25°C ... +85°C (standard)
T6	-40°C ... +85°C

Rollers	
	standard roller
R16	metal roller Ø 9.5x4 mm (for actuators 40, 42, 45, 46, 47, 53, 59 only)
R10	large plastic roller Ø 9.8x8.4 mm (for actuators 40, 42, 45, 53 only)

Contact type	
	silver contacts (standard)
G	silver contacts, 1 µm gold coating

Actuator	
01	pin
02	pin
03	narrow plunger
..

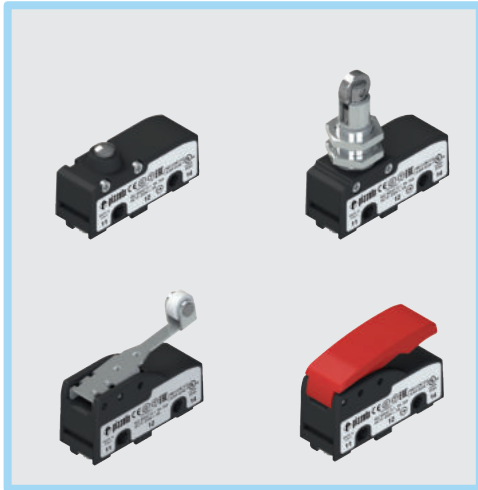

Main features

- Technopolymer housing
- High reliability contacts
- Protection degree up to IP65
- 4 terminal types available
- 52 actuators available
- Versions with positive opening ☺
- Versions with gold-plated silver contacts
- Terminal covers with strain relief cable gland

Quality marks:



IMQ approval:	CA02.05772
UL approval:	E131787
CCC approval:	2020970305002288
EAC approval:	RU C-IT.YT03.B.00035/19

Installation for safety applications:

Use only microswitches marked with the symbol ☺ next to the product code. Always connect the safety circuit to the **NC contacts** (normally closed contacts) as required by **EN ISO 14119, paragraph 5.4** for specific interlock applications and **EN ISO 13849-2 tables D3 (well-tried components) and D.8 (failure exclusions)** for safety applications in general. Actuate the switch **at least up to the positive opening travel (CAP)** reported next to the article code. Actuate the switch **at least with the positive opening force (FAP)** reported next to the article code.

⚠ If not expressly indicated in this chapter, for correct installation and utilization of all articles see the instructions given on pages 225 to 240.

Technical data

Housing

Housing made of glass fibre reinforced technopolymer, self-extinguishing and shock-proof.
 Protection degree acc. to EN 60529: IP00 without terminal cover
 IP20 (with terminal covers VF C01, VF C03)
 IP40 (with terminal covers VF MKC•1•, VF C02)
 IP65 (with terminal covers VF MKC•22 + MK V•2••• or VF MKC•23 + MK H•2•••)

General data

Ambient temperature: -25°C ... +85°C (standard)
 -40°C ... +85°C (T6 option)
 Max. actuation frequency: 3600 operating cycles/hour
 Mechanical endurance: 10 million operating cycles
 Safety parameter B_{10D}: 20,000,000 for NC contacts
 Tightening torques for installation: see page 237

Conductor cross section (flexible copper strands)

MK series: min. 1 x 0.34 mm² (1 x AWG 22)
 max. 2 x 1.5 mm² (2 x AWG 16)

Wire stripping length (x):

MK V••••• articles (screw connection): 7 mm

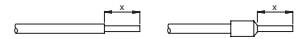

In compliance with standards:

IEC 60947-5-1, EN 60947-5-1, IEC 60529, EN 60529, EN 60947-1, IEC 60947-1, EN IEC 63000.

Approvals:

UL 508, CSA 22.2 No.14, EN 60947-1, EN 60947-5-1.

Compliance with the requirements of:

Low Voltage Directive 2014/35/EU, EMC Directive 2014/30/EU, RoHS Directive 2011/65/EU.

Positive contact opening in conformity with standards:

IEC 60947-5-1, EN 60947-5-1.

Electrical data

Thermal current (I _{th}):	16 A
Rated insulation voltage (U _i):	250 Vac 300 Vdc
Rated impulse withstand voltage (U _{imp}):	4 kV
Conditional short circuit current:	1000 A acc. to EN 60947-5-1
Protection against short circuits:	type gG fuse 16 A 250 V
Pollution degree:	3
Dielectric strength	2000 Vac/min.

Utilization category

Alternating current: AC15 (50 ... 60 Hz)			
U _e (V)	120	250	
I _e (A)	3	5	
Direct current: DC13			
U _e (V)	24	125	250
I _e (A)	4	0.6	0.3

Features approved by IMQ

Rated insulation voltage (U): 250 Vac
 Conventional free air thermal current (I_m): 16 A
 Protection against short circuits: type gG fuse 16 A 250 V
 Rated impulse withstand voltage (U_{imp}): 4 kV
 Conditional short circuit current: 1000 A
 Protection degree of the housing: IP00
 Terminals: screw terminals / faston

Pollution degree: 3
 Utilization category: AC15
 Operating voltage (U_e): 250 Vac (50 Hz)
 Operating current (I_e): 5 A

Forms of the contact element: A, B, C.
 Positive opening of contacts on contact blocks: 1, 3.
 In compliance with standards: EN 60947-1, EN 60947-5-1, fundamental requirements of the Low Voltage Directive 2014/35/EU.

Please contact our technical department for the list of approved products.

Features approved by UL

Electrical Ratings: Q300 pilot duty (69 VA, 125-250 V dc)
 A300 pilot duty (720 VA, 120-300 V ac)

Please contact our technical department for the list of approved products.

Circuit diagram

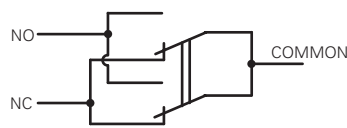

Mobile contact with single interruption and double contacts

With direct actuation and direct actuation at the back (F, D)

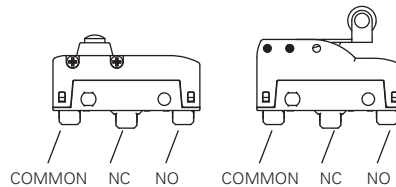

With inverted actuation (R)

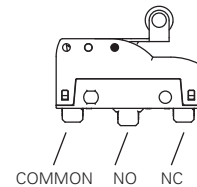

Actuation forces and travels

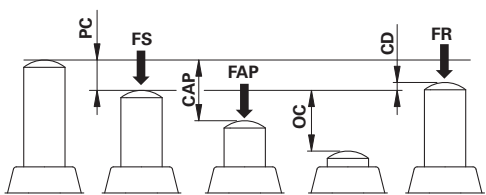

PC pre-travel
CAP positive opening travel
OC over-travel
CD differential travel

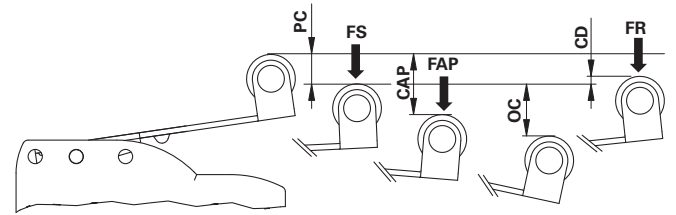

FS Trigger force
FR release force
FAP positive opening force

Microswitches with direct actuation

MK V11D01 1NO+1NC PC 0.5 mm OC 1.5 mm CD 0.05 mm FS 4 N FR 3 N	MK V11D02 1NO+1NC PC 0.5 mm OC 2 mm CD 0.05 mm FS 4 N FR 3 N
Maximum and minimum speed see page 237 - type 1	
MK V11D03 1NO+1NC PC 0.5 mm OC 2 mm CD 0.05 mm FS 4 N FR 3 N	MK V11D04 1NO+1NC PC 0.5 mm OC 2 mm CD 0.05 mm FS 4 N FR 3 N
Maximum and minimum speed see page 237 - type 1	

All values in the drawings are in mm

Accessories See page 207

→ The 2D and 3D files are available at www.pizzato.com

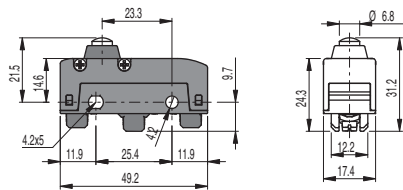

MK V11D05 (1NO+1NC)	PC 0.5 mm	FS 4 N
	OC 2 mm	FR 3 N
	CD 0.05 mm	FAP 20 N
	CAP 2.2 mm	

Maximum and minimum speed see page 237 - type 1

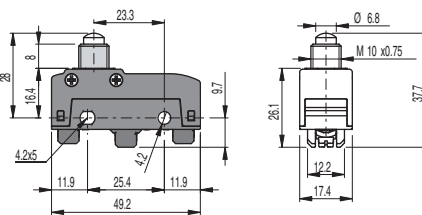

MK V11D06 (1NO+1NC)	PC 0.5 mm	FS 4 N
	OC 3 mm	FR 3 N
	CD 0.05 mm	FAP 20 N
	CAP 2.2 mm	

Maximum and minimum speed see page 237 - type 1

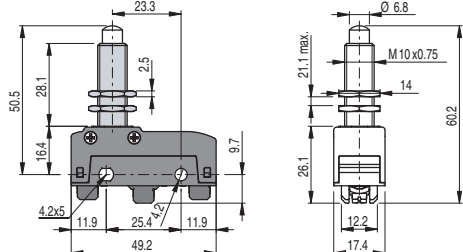

MK V11D08 (1NO+1NC)	PC 0.5 mm	FS 4 N
	OC 5.5 mm	FR 3 N
	CD 0.05 mm	FAP 20 N
	CAP 2.2 mm	

Maximum and minimum speed see page 237 - type 1

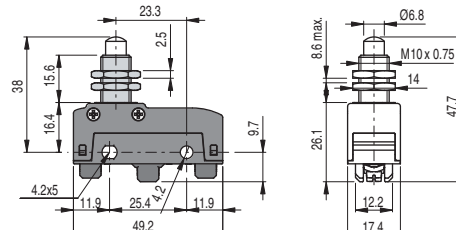

MK V11D09 (1NO+1NC)	PC 0.5 mm	FS 4 N
	OC 5.5 mm	FR 3 N
	CD 0.05 mm	FAP 20 N
	CAP 2.2 mm	

Maximum and minimum speed see page 237 - type 1

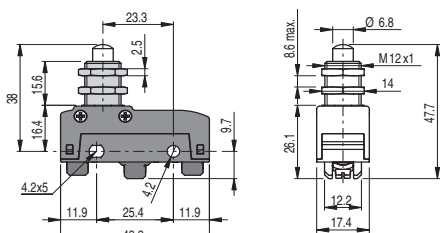

MK V11D10 (1NO+1NC)	PC 0.5 mm	FS 4 N
	OC 5.5 mm	FR 3 N
	CD 0.05 mm	FAP 20 N
	CAP 2.2 mm	

Maximum and minimum speed see page 237 - type 1

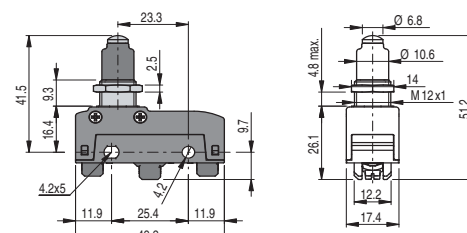

MK V11D12 (1NO+1NC)	PC 0.5 mm	FS 4.5 N
	OC 5.5 mm	FR 3 N
	CD 0.05 mm	FAP 20 N
	CAP 2.2 mm	

Maximum and minimum speed see page 237 - type 1

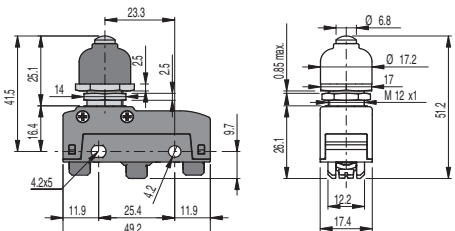

MK V11D13 (1NO+1NC)	PC 0.6 mm	FS 6 N
	OC 5.4 mm	FR 4 N
	CD 0.05 mm	FAP 20 N
	CAP 2.2 mm	

Maximum and minimum speed see page 237 - type 1

Mounting only through threaded fitting

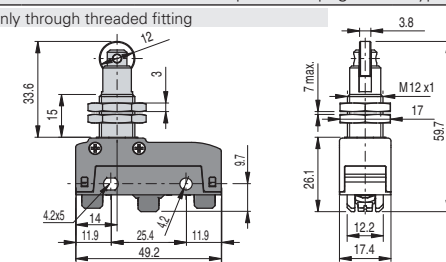

MK V11D15 (1NO+1NC)	PC 0.5 mm	FS 4 N
	OC 5.5 mm	FR 3 N
	CD 0.05 mm	FAP 20 N
	CAP 2.2 mm	

Maximum and minimum speed see page 237 - type 2

Mounting only through threaded fitting

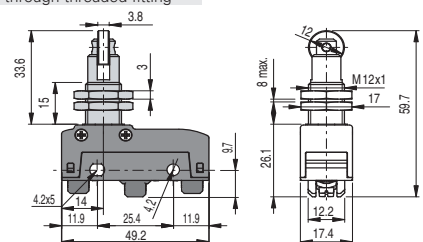

MK V11D17 (1NO+1NC)	PC 0.5 mm	FS 4 N
	OC 5.5 mm	FR 3 N
	CD 0.05 mm	FAP 20 N
	CAP 2.2 mm	

Maximum and minimum speed see page 237 - type 2

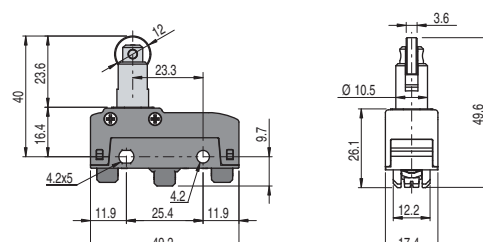

MK V11D18 (1NO+1NC)	PC 0.5 mm	FS 4 N
	OC 5.5 mm	FR 3 N
	CD 0.05 mm	FAP 20 N
	CAP 2.2 mm	

Maximum and minimum speed see page 237 - type 2

	MK V11D19 1NO+1NC PC 0.5 mm OC 5.5 mm CD 0.05 mm CAP 2.2 mm FS 4 N FR 3 N FAP 20 N		MK V11D30 1NO+1NC PC 11.5 mm OC 7.6 mm CD 1.1 mm FS 0.65 N FR 0.5 N
Maximum and minimum speed see page 237 - type 2		Maximum and minimum speed see page 237 - type 3	
	MK V11D31 1NO+1NC PC 4.6 mm OC 3.8 mm CD 0.4 mm FS 1.66 N FR 1.32 N		MK V11D32 1NO+1NC PC 9.1 mm OC 7.1 mm CD 0.9 mm FS 0.76 N FR 0.58 N
Maximum and minimum speed see page 237 - type 3		Maximum and minimum speed see page 237 - type 3	
	MK V11D35 1NO+1NC PC 26.2 mm OC 13.7 mm CD 2.5 mm FS 0.28 N FR 0.22 N		MK V11D37 1NO+1NC PC 24.8 mm OC 3.8 mm CD 4.1 mm FS 0.08 N FR 0.04 N
Maximum and minimum speed see page 237 - type 3		Maximum and minimum speed see page 237 - type 3	
	MK V11D40 1NO+1NC PC 8.2 mm OC 6.1 mm CD 0.8 mm FS 0.86 N FR 0.66 N		MK V11D42 1NO+1NC PC 6.5 mm OC 4.8 mm CD 0.6 mm FS 1.09 N FR 0.84 N
Maximum and minimum speed see page 237 - type 6		Maximum and minimum speed see page 237 - type 6	
	MK V11D45 1NO+1NC PC 4.5 mm OC 3.2 mm CD 0.4 mm FS 1.66 N FR 1.28 N		MK V11D46 1NO+1NC PC 4.1 mm OC 3.8 mm CD 0.4 mm FS 1.66 N FR 1.28 N
Maximum and minimum speed see page 237 - type 6		Maximum and minimum speed see page 237 - type 6	

All values in the drawings are in mm

Accessories See page 207

 → The 2D and 3D files are available at www.pizzato.com

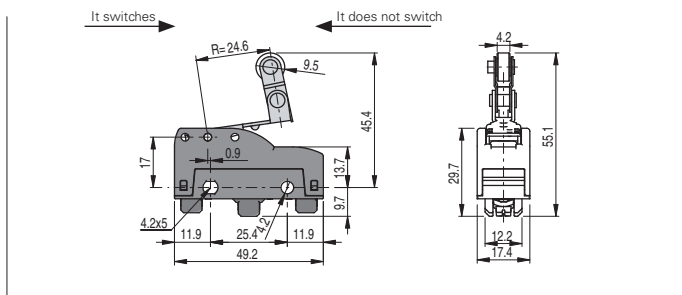

MK V11D47	1NO+1NC	PC	4.2 mm	FS	1.66 N
		OC	2.8 mm	FR	1.28 N
		CD	0.4 mm		

Maximum and minimum speed see page 237 - type 6

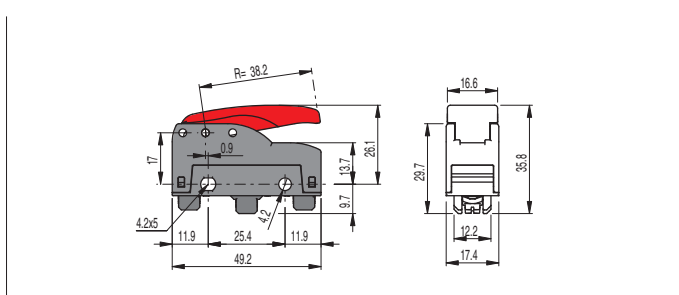

MK V11D49	1NO+1NC	Hand operated
------------------	---------	---------------

Maximum and minimum speed see page 237 - type 3

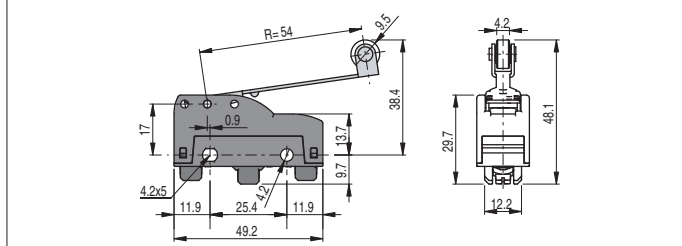

MK V11D53	1NO+1NC	PC	7.7 mm	FS	0.76 N
		OC	7.8 mm	FR	0.58 N
		CD	0.9 mm		

Maximum and minimum speed see page 237 - type 6

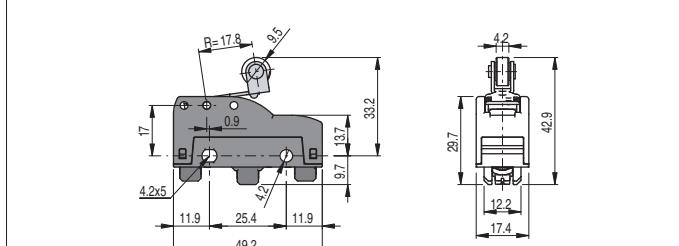

MK V11D59	1NO+1NC	PC	2.3 mm	FS	2.3 N
		OC	4.5 mm	FR	1.77 N
		CD	0.2 mm		

Maximum and minimum speed see page 237 - type 6

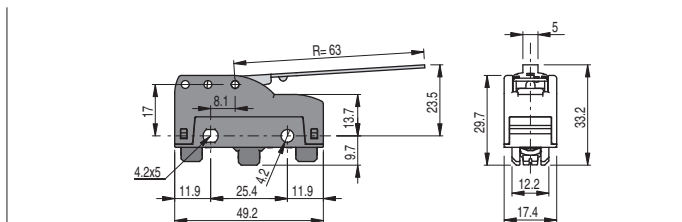
Microswitches with inverted actuation

MK V11R30	1NO+1NC	PC	5 mm	FS	0.6 N
		OC	14 mm	FR	0.4 N
		CD	0.7 mm		

Maximum and minimum speed see page 237 - type 4

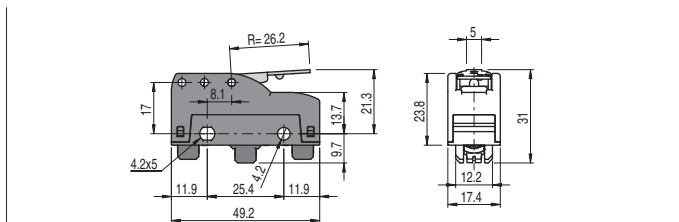

MK V11R31	1NO+1NC	PC	1.9 mm	FS	1.47 N
		OC	5.1 mm	FR	0.72 N
		CD	0.23 mm		

Maximum and minimum speed see page 237 - type 4

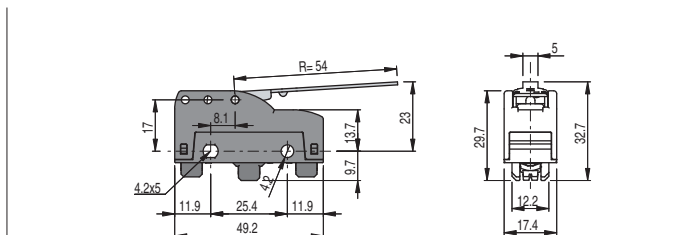

MK V11R32	1NO+1NC	PC	4.1 mm	FS	0.7 N
		OC	11.2 mm	FR	0.5 N
		CD	0.8 mm		

Maximum and minimum speed see page 237 - type 4

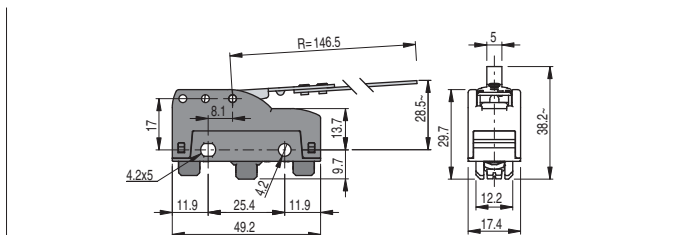

MK V11R35	1NO+1NC	PC	13.4 mm	FS	0.3 N
		OC	24.3 mm	FR	0.2 N
		CD	2.1 mm		

Maximum and minimum speed see page 237 - type 7

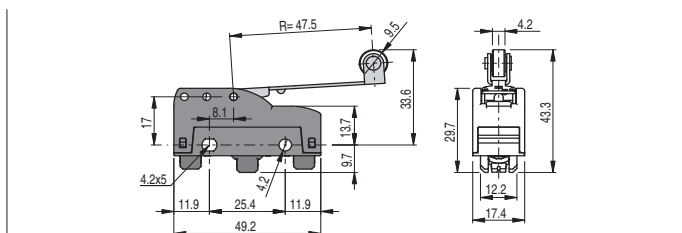

MK V11R40	1NO+1NC	PC	2.8 mm	FS	0.8 N
		OC	10.9 mm	FR	0.5 N
		CD	0.45 mm		

Maximum and minimum speed see page 237 - type 7

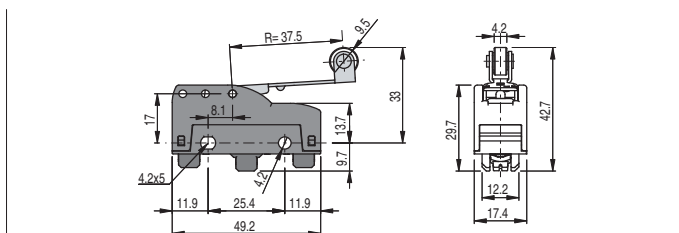

MK V11R42	1NO+1NC	PC	2.7 mm	FS	1.2 N
		OC	8.4 mm	FR	1.7 N
		CD	0.5 mm		

Maximum and minimum speed see page 237 - type 7



MK V11R45	1NO+1NC PC 1.5 mm OC 5.5 mm CD 0.3 mm	FS 1.7 N FR 1 N		MK V11R46	1NO+1NC PC 1.7 mm OC 4.8 mm CD 0.3 mm	FS 1.8 N FR 1.1 N	

Maximum and minimum speed see page 237 - type 7

Maximum and minimum speed see page 237 - type 7

MK V11R47	1NO+1NC PC 1.7 mm OC 5.3 mm CD 0.3 mm	FS 1.7 N FR 1 N		MK V11R53	1NO+1NC PC 3.6 mm OC 11.2 mm CD 0.5 mm	FS 0.8 N FR 0.4 N	

Maximum and minimum speed see page 237 - type 7

Maximum and minimum speed see page 237 - type 7

MK V11R59	1NO+1NC PC 1.5 mm OC 3.9 mm CD 0.2 mm	FS 2.4 N FR 1.3 N		MK V11R60	1NO+1NC PC 2.7 mm OC 9.2 mm CD 0.5 mm	FS 1.2 N FR 0.6 N	

Maximum and minimum speed see page 237 - type 7

Maximum and minimum speed see page 237 - type 4

Microswitches with direct actuation at the back

MK V11F30	1NO+1NC PC 3.2 mm OC 11.2 mm CD 0.35 mm	FS 0.6 N FR 0.5 N		MK V11F31	1NO+1NC PC 1.45 mm OC 5 mm CD 0.17 mm CAP 5.72 mm	FS 1.5 N FR 0.92 N FAP 5.78 N	

Maximum and minimum speed see page 237 - type 5

Maximum and minimum speed see page 237 - type 5

MK V11F32	1NO+1NC PC 2.7 mm OC 9.3 mm CD 0.4 mm	FS 0.7 N FR 0.6 N		MK V11F35	1NO+1NC PC 7.8 mm OC 24.1 mm CD 1.7 mm	FS 0.25 N FR 0.2 N	

Maximum and minimum speed see page 237 - type 5

Maximum and minimum speed see page 237 - type 5

All values in the drawings are in mm

Accessories See page 207

The 2D and 3D files are available at www.pizzato.com

MK V11F40	1NO+1NC	PC 2.1 mm OC 8.3 mm CD 0.25 mm	FS 0.85 N FR 0.65 N
------------------	---------	--------------------------------------	------------------------

Maximum and minimum speed see page 237 - type 8

MK V11F42	1NO+1NC	PC 1.8 mm OC 6.7 mm CD 0.2 mm CAP 8 mm	FS 1 N FR 0.7 N FAP 4.9 N
------------------	---------	---	---------------------------------

Maximum and minimum speed see page 237 - type 8

MK V11F45	1NO+1NC	PC 1.1 mm OC 4.9 mm CD 0.1 mm CAP 5.8 mm	FS 1.5 N FR 0.9 N FAP 6.9 N
------------------	---------	---	-----------------------------------

Maximum and minimum speed see page 237 - type 8

MK V11F46	1NO+1NC	PC 1.3 mm OC 4.7 mm CD 0.1 mm CAP 5.8 mm	FS 1.6 N FR 0.9 N FAP 6.9 N
------------------	---------	---	-----------------------------------

Maximum and minimum speed see page 237 - type 8

MK V11F47	1NO+1NC	PC 1.3 mm OC 4.7 mm CD 0.1 mm CAP 5.8 mm	FS 1.6 N FR 0.9 N FAP 6.9 N
------------------	---------	---	-----------------------------------

Maximum and minimum speed see page 237 - type 8

MK V11F49	1NO+1NC	PC 1.5 mm OC 7.5 mm CD 0.2 mm CAP 8 mm	FS 1 N FR 0.7 N FAP 4.8 N
------------------	---------	---	---------------------------------

Maximum and minimum speed see page 237 - type 5

MK V11F53	1NO+1NC	PC 2.5 mm OC 9.3 mm CD 0.3 mm	FS 0.7 N FR 0.6 N
------------------	---------	-------------------------------------	----------------------

Maximum and minimum speed see page 237 - type 8

MK V11F59	1NO+1NC	PC 0.8 mm OC 4.5 mm CD 0.08 mm CAP 4.9 mm	FS 1.9 N FR 1.3 N FAP 8.9 N
------------------	---------	--	-----------------------------------

Maximum and minimum speed see page 237 - type 8

Terminal dimensions

All values in the drawings are in mm

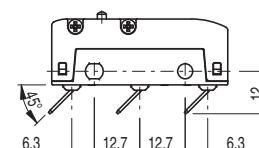
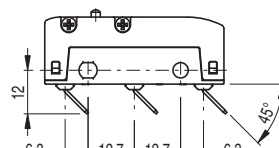
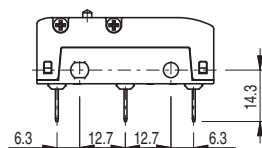
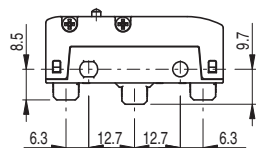
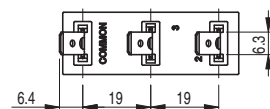
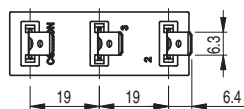
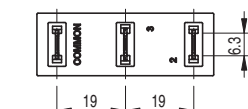
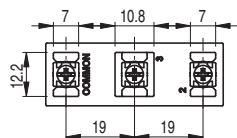

Screw terminals **V** with plate

Faston terminals **H**, vertical

Faston terminals **F**, right angle

Faston terminals **G**, left angle (upon request)

Note: The vertical faston terminals H can be bent according to specific installation requirements.

We recommend to bend the faston with an angle not higher than 45° and to carry out this operation no more than 5 times.

Protective terminal covers

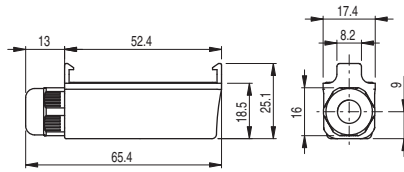
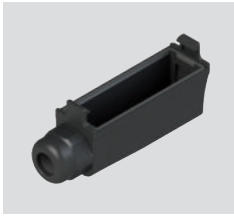
 Packs of **10 pcs.**

Protective terminal cover for screw terminals with strain relief cable gland and snap-in mounting. It allows to install multiple switches side-by-side.

Article	Description	Protection degree
VF MKCV11	Protective terminal cover without gasket for multipolar cables \varnothing 5 ... 7.5 mm	IP40
VF MKCV12	Protective terminal cover without gasket for multipolar cables \varnothing 4 ... 7.5 mm	IP40
VF MKCV13	Protective terminal cover without gasket for multipolar cables \varnothing 2 ... 5.5 mm	IP40
VF MKCV22	Protective terminal cover with gasket for multipolar cables \varnothing 4 ... 7.5 mm	IP65
VF MKCV23	Protective terminal cover with gasket for multipolar cables \varnothing 2 ... 5.5 mm	IP65

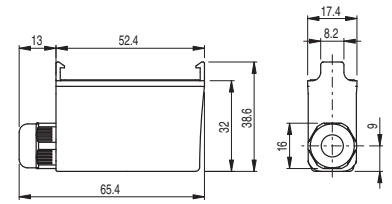
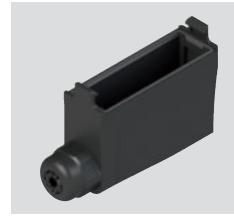

Protective terminal cover for vertical faston terminals with strain relief cable gland and snap-in mounting. It allows to install multiple switches side-by-side.

Article	Description	Protection degree
VF MKCH11	Protective terminal cover without gasket for multipolar cables \varnothing 5 ... 7.5 mm	IP40
VF MKCH12	Protective terminal cover without gasket for multipolar cables \varnothing 4 ... 7.5 mm	IP40
VF MKCH13	Protective terminal cover without gasket for multipolar cables \varnothing 2 ... 5.5 mm	IP40
VF MKCH22	Protective terminal cover with gasket for multipolar cables \varnothing 4 ... 7.5 mm	IP65
VF MKCH23	Protective terminal cover with gasket for multipolar cables \varnothing 2 ... 5.5 mm	IP65

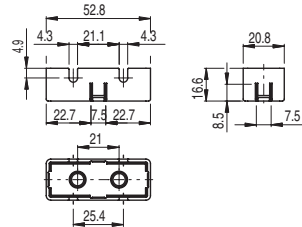

Article	Description	Protection degree
VF C01	Protective terminal cover for screw terminals	IP20

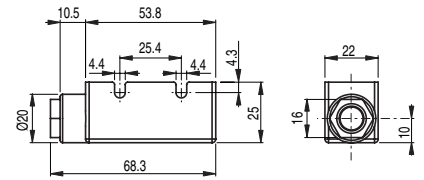
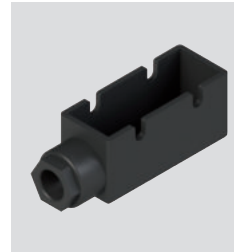

Article	Description	Protection degree
VF C02	Protective terminal cover for screw terminals with PG9 cable gland for multipolar cables \varnothing 5 ... 7 mm	IP40

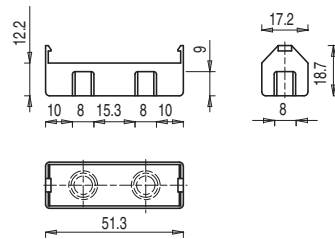

Article	Description	Protection degree
VF C03	Protective terminal cover for screw terminals, snap-in mounting. It allows to install multiple switches side-by-side	IP20

Accessories

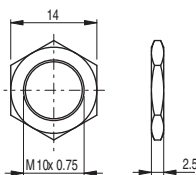
 Packs of **10 pcs.**

Article	Description
VF AC83	Hex threaded nut for microswitches with actuators D06, D08, D09

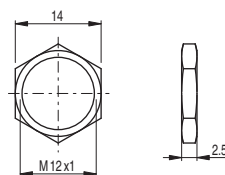

Article	Description
VF AC72	Hex threaded nut for microswitches with actuators D10, D12, D13

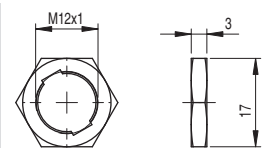

Article	Description
AC 35	Hex threaded nut, notched, for microswitches with actuators D15, D17