

Electronic Timer - Series Micon® 175

- Compact 17.5mm Wide
- Integrated Dual Voltage
- Functions: ON Delay, Star Delta, One Shot
- Wide Time Range: 0.3s - 30h
- LED Indications for Power and Relay status
- Low Power Consumption



Ordering Information

Cat. No.	Description
11ODT4	110 VAC / 24 VAC/DC, ON Delay Timer, 1 C/O
12ODT4	240 VAC / 24 VAC/DC, ON Delay Timer, 1 C/O
15ODT4	12 VDC, ON Delay Timer, 1 C/O
11RDT4	110 VAC / 24 VAC/DC, Signal OFF Delay Timer, 1 C/O
12RDT4	240 VAC / 24 VAC/DC, Signal OFF Delay Timer, 1 C/O
11BDT4	110 VAC / 24 VAC/DC, One Shot Timer, 1 C/O
12BDT4	240 VAC / 24 VAC/DC, One Shot Timer, 1 C/O
15BDT4	12 VDC, One Shot Timer, 1 C/O

Electronic Timer - Series Micon® 175



Cat. No.	12ODT4	12RDT4
Parameters		
Timer Description	ON Delay Timer	Signal OFF Delay Timer
Mode	ON Delay	Signal OFF Delay
Functional Diagram		
Supply Voltage (ϕ)	240 VAC / 24 VAC/DC	240 VAC / 24 VAC/DC
Supply Variation	- 20% to +10% (of ϕ)	- 15% to +10% (of ϕ)
Frequency	50/60 Hz	50/60 Hz
Power Consumption (Max.)	8 VA	8 VA
Timing Ranges	0.3s to 30h	0.3s to 30h
Reset Time	100 ms (Max.)	150 ms (Max.)
Setting Accuracy	\pm 5% of Full scale	
Repeat Accuracy	\pm 1%	
Output	Relay Output	1 C/O
	Contact Rating	5A @ 240 VAC / 28 VDC (Resistive) 5A @ 240 VAC / 3A @ 30 VDC (Resistive)
	Electrical Life	1X10 ⁵
	Mechanical Life	5X10 ⁵
Utilization Category	AC - 15	Rated Voltage (Ue): 120/240 V, Rated Current (Ie): 3.0/1.5 A
	DC - 13	Rated Voltage (Ue): 24/125/250 V, Rated Current (Ie): 2.0/0.22/0.1 A
Operating Temperature	-10°C to +55°C	
Storage Temperature	-20°C to +70°C	
Humidity (Non Condensing)	95% (Rh)	
LED Indication	Green LED → Power ON, Red LED → Relay ON	
Enclosure	Flame Retardant UL94-V0	
Dimension (W x H x D) (in mm)	17.5 X 90 X 58.5	
Weight (unpacked) Approx.	65 g	
Mounting	Base / DIN Rail	
Certification		
Degree of Protection	IP 20 for Terminals, IP 40 for Enclosure	

EMI / EMC

Harmonic Current Emissions	IEC 61000-3-2
ESD	IEC 61000-4-2
Radiated Susceptibility	IEC 61000-4-3
Electrical Fast Transients	IEC 61000-4-4
Surges	IEC 61000-4-5
Conducted Susceptibility	IEC 61000-4-6
Voltage Dips & Interruptions (AC)	IEC 61000-4-11
Voltage Dips & Interruptions (DC)	IEC 61000-4-29
Conducted Emission	CISPR 14-1
Radiated Emission	CISPR 14-1

Environmental

Cold Heat	IEC 60068-2-1
Dry Heat	IEC 60068-2-2
Vibration	IEC 60068-2-6
Repetitive Shock	IEC 60068-2-27
Non-Repetitive Shock	IEC 60068-2-27

Electronic Timer - Series Micon® 175



Ordering Information

Cat. No.	Description
11SDT0	110 VAC, Star Delta Timer, 1 NO (Star) + 1 NO (Delta)
12SDT0	240 VAC, Star Delta Timer, 1 NO (Star) + 1 NO (Delta)
14SDT1S	240-415V AC, Star Delta Timer, 1C/O (Star) + 1C/O (Delta), 3-30 Sec.

Electronic Timer - Series Micon® 175



Cat. No.	12SDT0	
Parameters		
Timer Description	Star Delta Timer	
Mode	Star Delta	
Functional Diagram		
Supply Voltage (Φ)	240 VAC	
Supply Variation	- 20% to +10% (of Φ)	
Frequency	50 Hz	
Power Consumption (Max.)	8 VA	
Timing Ranges	3s to 120s	
Pause Time	60 ms	
Reset Time	150 ms (Max.)	
Setting Accuracy	± 5% of Full scale	
Repeat Accuracy	± 1%	
Output	Relay Output	Star - 1 'NO', Delta - 1 'NO'
	Contact Rating	5A @ 240 VAC / 3A @ 30 VDC (Resistive)
	Electrical Life	1X10 ⁵
	Mechanical Life	5X10 ⁶
Utilization Category	AC - 15	Rated Voltage (Ue): 120/240 V, Rated Current (Ie): 3.0/1.5 A
	DC - 13	Rated Voltage (Ue): 24/125/250 V, Rated Current (Ie): 2.0/0.22/0.1 A
Operating Temperature	-10°C to +55°C	
Storage Temperature	-20°C to +70°C	
Humidity (Non Condensing)	95% (Rh)	
LED Indication	Red LED 1 → 'Δ' ON, Red LED 2 → 'T' ON	
Enclosure	Flame Retardant UL94-V0	
Dimension (W x H x D) (in mm)	17.5 X 90 X 58.5	
Weight (unpacked)	60 g	
Mounting	Base / DIN Rail	
Certification		
Degree of Protection	IP 20 for Terminals, IP 40 for Enclosure	

EMI / EMC

Harmonic Current Emissions	IEC 61000-3-2
ESD	IEC 61000-4-2
Radiated Susceptibility	IEC 61000-4-3
Electrical Fast Transients	IEC 61000-4-4
Surges	IEC 61000-4-5
Conducted Susceptibility	IEC 61000-4-6
Voltage Dips & Interruptions (AC)	IEC 61000-4-11
Voltage Dips & Interruptions (DC)	IEC 61000-4-29
Conducted Emission	CISPR 14-1
Radiated Emission	CISPR 14-1

Environmental

Cold Heat	IEC 60068-2-1
Dry Heat	IEC 60068-2-2
Vibration	IEC 60068-2-6
Repetitive Shock	IEC 60068-2-27
Non-Repetitive Shock	IEC 60068-2-27

Electronic Timer - Series Micon® 175

- Multi Function: 10 Different (Non Signal & Signal based) Modes
- Wide Voltage range for both AC & DC
- Wide Time range: 0.1s - 100h
- LED Indications for Power and Relay status
- Independent settings for both ON Time & OFF Time
- Low Power Consumption





Ordering Information

Cat. No.	Description
1CMDT0	12 - 240 VAC/DC, Multi Function Timer (10 Modes), 1 C/O (RAL 7016 Casing)
1CJDT0	12 - 240 VAC/DC, Asymmetric Timer, 1 C/O(RAL 7016 Casing)
1CMDTB	12 - 240 VAC/DC, Multi Function Timer (10 Modes), 1 C/O (RAL 7035 Casing)
1CJDTB	12 - 240 VAC/DC, Asymmetric Timer, 1 C/O (RAL 7035 Casing)

Electronic Timer - Series Micon® 175



Cat. No.		1CJDT0	1CMDT0
Parameters			
Timer Description		Asymmetric Timer	Multi Function Timer
Modes		1) Asymmetric ON-OFF, 2) Asymmetric OFF-ON	1) Signal ON Delay 2) Cyclic ON/OFF 3) Cyclic OFF/ON 4) Signal OFF Delay 5) Signal OFF/ON 6) Accumulative Delay on Signal 7) Impulse ON/OFF 8) Leading Edge Impulse 9) Trailing Edge Impulse 10) Leading Edge Bi-stable
Derived Modes		N A	ON Delay, Interval
Supply Voltage (Φ)		12 - 240 VAC/DC	
Supply Variation		-15% to +10% (of Φ)	
Frequency		50/60 Hz	
Power Consumption (Max.)		2 VA	
Timing Range		0.1s to 100h	
Reset Time		200 ms (Max)	
Setting Accuracy		± 5% of Full scale	
Repeat Accuracy		± 1%	
Output	Relay Output	1 C/O	1 C/O
	Contact Rating	8A @ 240 VAC / 5A @ 24 VDC (Resistive)	8A @ 240 VAC / 5A @ 24 VDC (Resistive)
	Electrical Life	1X10 ⁵	
	Mechanical Life	5X10 ⁶	
Utilization Category	AC - 15 DC - 13	Rated Voltage (Ue): 120/240 V, Rated Current (Ie): 3.0/1.5 A Rated Voltage (Ue): 24/125/250 V, Rated Current (Ie): 2.0/0.22/0.1 A	
Operating Temperature		-10°C to +60°C	
Storage Temperature		-15°C to +70°C	
LED Indication		Green LED → Power ON, Amber LED → Relay ON	Green LED → Power ON, Yellow LED → Relay ON
Enclosure		Flame Retardant UL94-V0	
Dimension (W x H x D) (in mm)		18 X 85 X 65	
Weight (unpacked)		70 g	
Mounting		DIN Rail	
Certification		  	
Degree of Protection		IP 20 for Terminals, IP 40 for Enclosure	

EMI / EMC

Harmonic Current Emissions	IEC 61000-3-2
ESD	IEC 61000-4-2
Radiated Susceptibility	IEC 61000-4-3
Electrical Fast Transients	IEC 61000-4-4
Surges	IEC 61000-4-5
Conducted Susceptibility	IEC 61000-4-6
Voltage Dips & Interruptions (AC)	IEC 61000-4-11
Voltage Dips & Interruptions (DC)	IEC 61000-4-29
Conducted Emission	CISPR 14-1
Radiated Emission	CISPR 14-1

Environmental

Cold Heat	IEC 60068-2-1
Dry Heat	IEC 60068-2-2
Vibration	IEC 60068-2-6
Repetitive Shock	IEC 60068-2-27
Non-Repetitive Shock	IEC 60068-2-27

Electronic Timer - Series Micon® 175



FUNCTIONAL DIAGRAMS FOR 1CMDT0

☐: Supply Voltage, S: Input Signal, R: Relay Output
T: Preset Time, TON: Preset ON Time, TOFF: Preset OFF Time

SIGNAL ON DELAY [stn]

On application of input signal, the preset delay time period starts. On completion of the preset time, the output is switched ON and remains ON till the input signal is present.

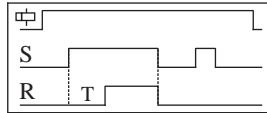

ACCUMULATIVE DELAY On SIGNAL [san]

On application of supply voltage, the preset delay time period starts. If input signal is applied during this period, the preset time stops and resumes only when the input signal is removed. On completion of the preset time, the output is switched ON.

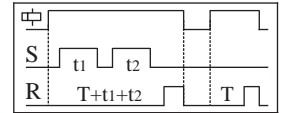

CYCLIC ON/OFF [cnf]

On application of supply voltage, the output is initially switched ON for the preset time duration (T) after which it is switched OFF for the same time duration (T). This cycle continues till the power supply is present.



IMPULSE ON/OFF [inf]

On application or removal of input signal to the timer, the output is immediately switched ON for the preset time duration (T). If the state of the input signal is changed during the preset time, the output does not change state only the time is reset.

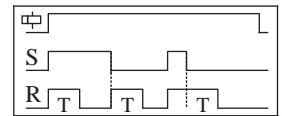

CYCLIC OFF/ON [cfn]

On application of supply voltage, the output is initially switched OFF for the preset time duration (T) after which it is switched ON for the same time duration (T). This cycle continues till the power supply is present.



LEADING EDGE IMPULSE [il]

When input signal is applied to the timer the output is immediately switched ON. The output remains ON for the preset time duration (T) after which it is switched OFF. If the input signal is removed during the preset time, the output is immediately switched OFF.

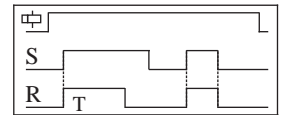

SIGNAL OFF DELAY [sf]

On application of input signal to the timer, the output is immediately switched ON. When the input signal is switched OFF, the preset time delay period starts. On completion of the time period the output is switched OFF.

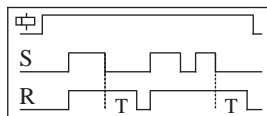

TRAILING EDGE IMPULSE [it]

When the input signal to the timer is removed, the output is immediately switched ON for the preset time duration (T) after which it is switched OFF. If the input signal is applied during the preset time, the output is immediately switched OFF.

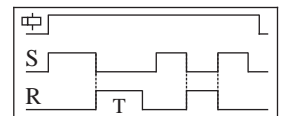

SIGNAL OFF/ON [sfn]

On application of input signal to the timer, the preset delay time period (T) starts. On completion of the time preset time, the output is switched ON. When the input signal is switched OFF, again the preset time delay period (T) starts. On completion of the time period the output is switched OFF.

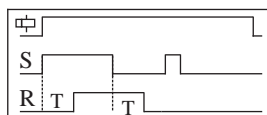

LEADING EDGE BISTABLE [sbi]

On application of input signal to the timer, the output is switched ON and remains ON even after the input signal is removed. On subsequent application of input signal, the output keeps on changing its state.

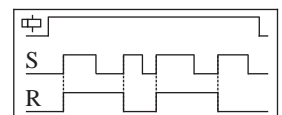

DERIVED MODES

Select mode, 'Signal ON Delay' and short the connection between A1 - B1 before power ON. Select mode, 'Accumulative Delay ON Signal' and keep the connection between A1 - B1 open.

ON DELAY

When supply power is applied to the timer, the preset delay time period starts. On completion of the preset time, the output is switched ON and remains ON till the input supply is present.

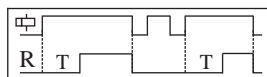

Select mode, "Leading Edge Impulse" and short the connection between A1 & B1.

INTERVAL

When supply power is applied to the timer, the output is instantly switched ON. On completion of the preset time, the output is switched OFF.

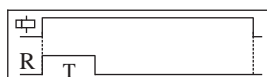

FUNCTIONAL DIAGRAMS FOR 1CJDT0

ASYMMETRIC ON-OFF

On application of supply voltage, the output is initially switched ON for the preset 'ON' time duration (T) after which it is switched OFF for the preset 'OFF' time duration (T). This cycle repeats and continues till the supply is present. The ON time & OFF time are set independently.



ASYMMETRIC OFF-ON

On application of supply voltage, the output is initially switched OFF for the preset 'OFF' time duration (T) after which it is switched ON for the preset 'ON' time duration (T). This cycle repeats and continues till the supply is present. The ON time & OFF time are set independently.



Electronic Timer - Series Micon® 175

MOUNTING DIMENSIONS (mm)

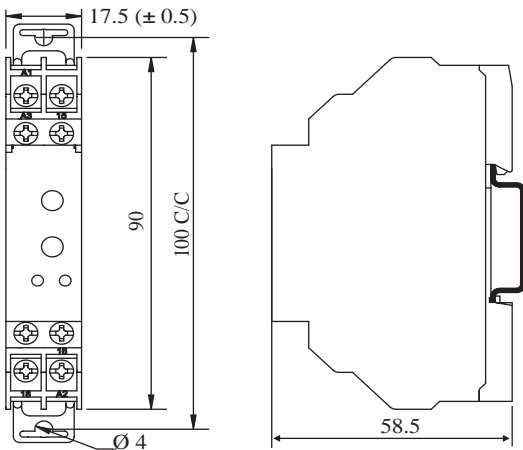
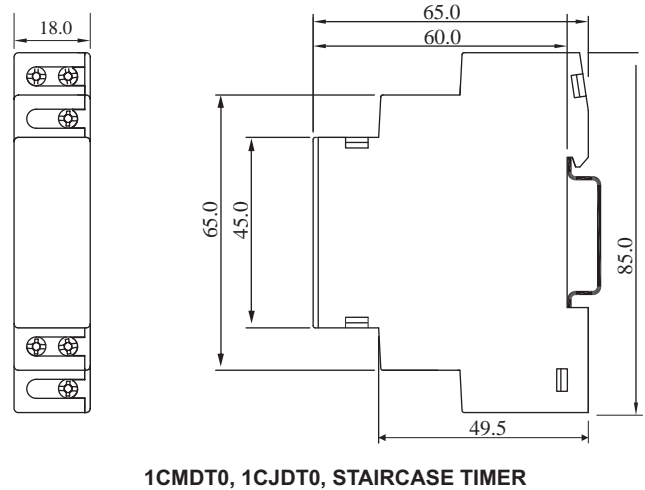
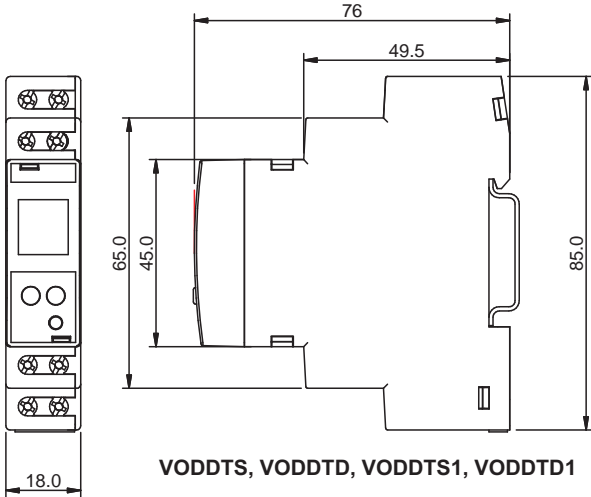

CONNECTION DIAGRAM

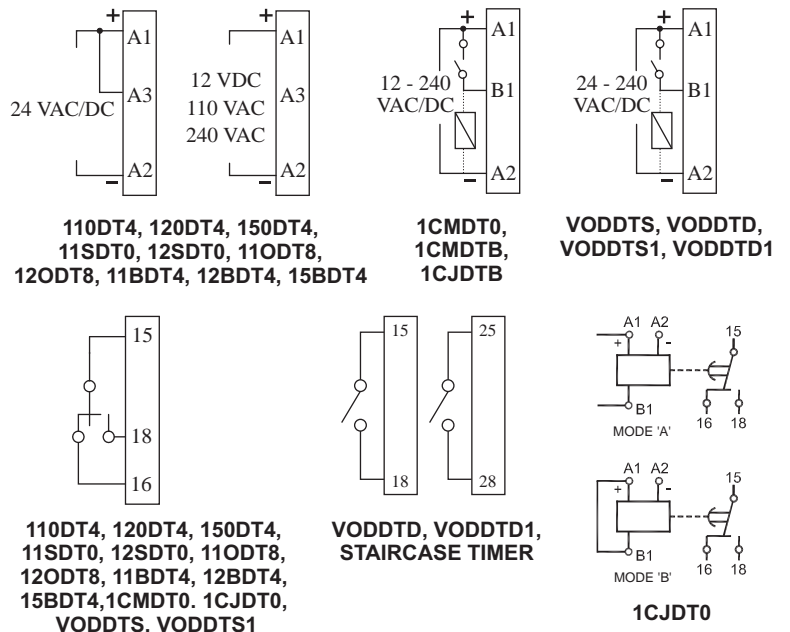

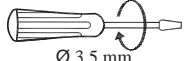
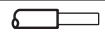

TERMINAL TORQUE & CAPACITY

 Ø 3.5 mm	Torque - 0.40 N.m (3.5 Lb.in) Terminal screw - M2.5
	Solid Wire - 1 X 0.3...2.5 mm ²
AWG	1 X 22 to 14

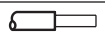
VODDTS, VODDTD, VODDTS1, VODDTD1

 Ø 3.5...4.0 mm	Torque - 0.6 N.m (6 Lb.in) Terminal screw - M3
	Solid Wire - 1 X 1...4 mm ²
AWG	1 X 18 to 10

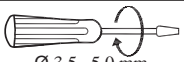
1CMDT0, 1CJDT0, STAIRCASE TIMER

 Ø 3.5...5.0 mm	Torque - 1.1 N.m (10 Lb.in) Terminal screw - M3.5
	Solid Wire - 2 X 0.2...2.5 mm ²
AWG	1 X 24 to 10

110DT4, 120DT4, 150DT4, 11SDT0, 12SDT0
11ODT8, 12ODT8, 11BDT4, 12BDT4, 15BDT4

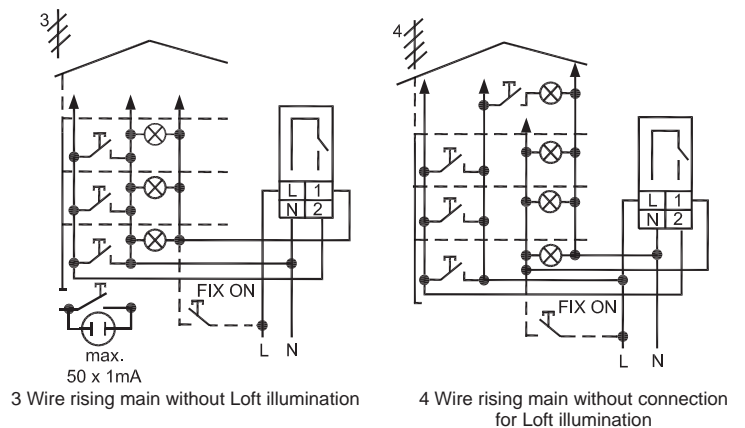

STAIRCASE TIMER