

Product datasheet

Specifications



photo-electric sensor - XUKT - reflex - Sn 1.5m - 12..24VDC - cable 2m

Local distributor code: 386333268 XUKT1KSML2

EAN Code : 3389110077216

Main

Range of product	Telemecanique Photoelectric sensors XU
Series name	Application packaging
Electronic sensor type	Photo-electric sensor
Sensor name	XUK
Sensor design	Compact 50 x 50
Detection system	Reflex
Material	Plastic
Type of output signal	Discrete
Supply circuit type	DC
Wiring technique	3-wire
Discrete output type	PNP or NPN
Discrete output function	1 NO or 1 NC programmable
Electrical connection	Cable
Cable length	2 m
Product specific application	Detection of transparent object
Emission	Red reflex
[Sn] nominal sensing distance	1.5 m reflex need reflector XUZC50

Complementary

Enclosure material	PC
Lens material	PMMA
Output type	Solid state
Output function governance	Dark
Add on output	Without
Cable composition	2 x 0.34 mm ²
Wire insulation material	PVC
Cable outer diameter	6 mm
Status LED	1 LED for output state
[Us] rated supply voltage	12...24 V DC with reverse polarity protection

Supply voltage limits	10...30 V AC/DC
Switching capacity in mA	<= 100 mA (overload and short-circuit protection)
Switching frequency	<= 1.5 kHz
Maximum voltage drop	<2 V (closed state)
Current consumption	<= 35 mA no-load
Time delay range	0.1...5 s monostable, on-delay or off-delay (programmable) delay
Maximum delay first up	80 ms
Maximum delay response	0.3 ms
Maximum delay recovery	0.3 ms
Setting-up	Sensitivity adjustment by potentiometer
Depth	50 mm
Height	50 mm
Width	18 mm
Net weight	0.035 kg
Kit composition	Bracket XULZ41 Sensor

Environment

Product certifications	CE UL CSA
Ambient air temperature for operation	-25...55 °C
Ambient air temperature for storage	-40...70 °C
Vibration resistance	7 gn, amplitude = +/- 2 mm (f = 10...55 Hz) conforming to IEC 60068-2-6
Shock resistance	20 gn (duration = 11 ms) conforming to IEC 60068-2-27
IP degree of protection	IP65 conforming to IEC 60529 IP651 conforming to NF C 20-010

Packing Units

Unit Type of Package 1	PCE
Number of Units in Package 1	1
Package 1 Weight	254.0 g
Package 1 Height	4.2 cm
Package 1 width	9.7 cm
Package 1 Length	13.2 cm
Unit Type of Package 2	S02
Number of Units in Package 2	12
Package 2 Weight	3.45 kg
Package 2 Height	15.0 cm
Package 2 width	30.0 cm
Package 2 Length	40.0 cm

Offer Sustainability

Sustainable offer status	Green Premium product
REACH Regulation	REACH Declaration

EU RoHS Directive	Pro-active compliance (Product out of EU RoHS legal scope) EU RoHS Declaration
Mercury free	Yes
RoHS exemption information	Yes
Environmental Disclosure	Product Environmental Profile
Circularity Profile	End of Life Information

Contractual warranty

Warranty	18 months
-----------------	-----------

Dimensions

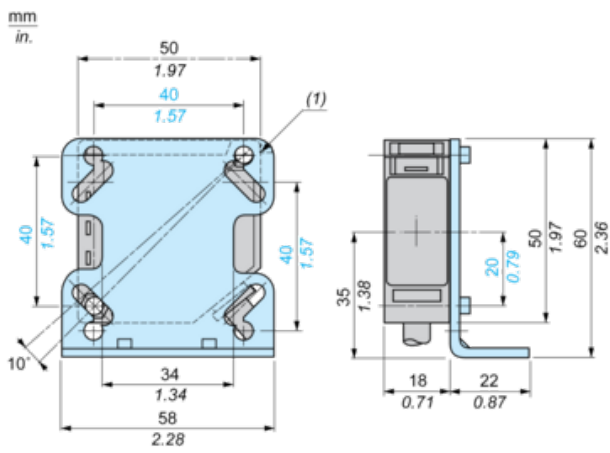

(1) Cover locking tongue

Bracket Fixing

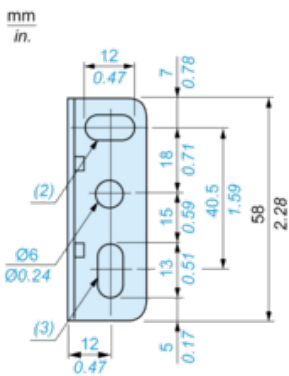

(2) 1 elongated hole $\varnothing 6 \times 12$

(3) 1 elongated hole $\varnothing 6 \times 13$

Wiring Schemes

Connector Scheme

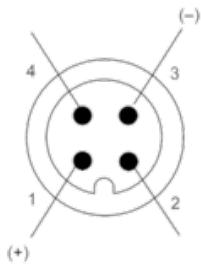

- 1 : (+)
- 2 : Alarm output
- 3 : (-)
- 4 : Output signal

NC Programmed

PNP programmed output

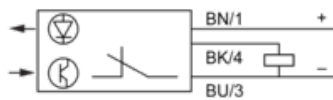

- BN : Brown
- BK : Black
- BU : Blue

NPN programmed output

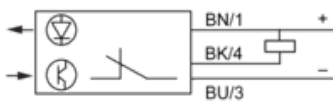

- BN : Brown
- BK : Black
- BU : Blue

NO Programmed

PNP programmed output

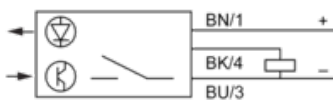

- BN : Brown
- BK : Black
- BU : Blue

NPN programmed output

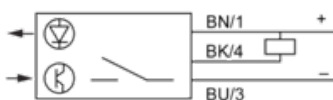

- BN : Brown
- BK : Black
- BU : Blue

Alarm Output

PNP programmed



- BN : Brown
- WH : White
- BU : Blue

NPN programmed



- BN : Brown

WH : White
BU : Blue