

# ATE8 Series

## DIN W48×H48mm Analog Timer

Upgrade

### ■ Features

- DIN W48×H48mm
- Easy and simple time setting
- Cost-effective
- Easy time setting
- **Wide range of time**
- Power supply: 100-240VAC 50/60Hz, 24-240VDC

Shaded parts(■) are changed and added functions from previous ATE Series.



⚠ Please read "Safety considerations" in operation manual before using.



### ■ Ordering Information

ATE 8 - 4 3 D

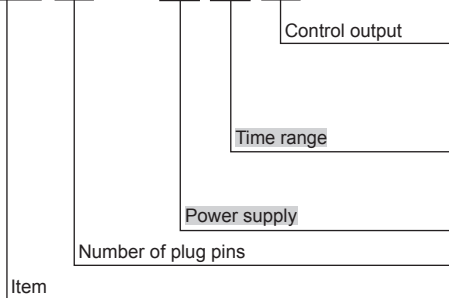

No mark	Time limit SPDT (1c)+Instantaneous SPST (1a)
D	Time limit DPDT (2c)
E	Time limit SPDT (1c)+Instantaneous SPST (1c)
1	1 sec/10 sec/1 min/10 min/1 hour
3	3 sec/30 sec/3 min/30 min/3 hour
6	6 sec/60 sec/6 min/60 min/6 hour
C	12 sec/12 min/24 min/12 hour/24 hour
4	100-240VAC 50/60Hz, 24-240VDC
8	8-pin plug type
ATE	Analog timer

※Sockets (PG-08, PS-08(N)) are sold separately.

### ■ Specifications

Model	ATE8-4□	ATE8-4□D	ATE8-4□E
Function	Power ON Delay Timer		
Control time setting range*1	0.1 sec to 24 hour		
Power supply	100-240VAC~ 50/60Hz, 24-240VDC---		
Permissible voltage range	90 to 110% of rated voltage		
Power consumption	Max. 3.5VA (100-240VAC~ 50/60Hz), Max. 2.0W (24-240VDC---		
Return time	Max. 200ms		
Time operation	Power ON Start		
Control output	Contact type	Time-limit SPDT (1c)+ Instantaneous SPST (1a)	Time-limit DPDT (2c)
	Contact capacity	250VAC~ 3A resistive load	
Relay life cycle	Mechanical	Min. 5,000,000 operations	
	Electrical	Min. 100,000 operations (250VAC 3A resistive load)	
Repeat error	Max. ±0.3% ±0.01 sec		
Set error	Max. ±5% ±0.05 sec		
Voltage error	Max. ±0.5% ±0.01 sec		
Temp. error	Max. ±2% ±0.01 sec		
Insulation resistance	Over 100MΩ (at 500VDC megger)		
Dielectric strength	2,000VAC 50/60Hz for 1min		
Noise immunity	±2KV the square wave noise (pulse width 1μs) by noise simulator		
Vibration	Mechanical	0.75mm amplitude at frequency 10 to 55Hz (for 1min) in each X, Y, Z direction for 1 hour	
	Malfunction	0.5mm amplitude at frequency 10 to 55Hz (for 1 min) in each X, Y, Z direction for 10 min	
Shock	Mechanical	300m/s <sup>2</sup> (approx. 30G) in each X, Y, Z direction for 3 times	
	Malfunction	100m/s <sup>2</sup> (approx. 10G) in each X, Y, Z direction for 3 times	
Environment	Ambient temp.	-10 to 55°C, storage: -25 to 65°C	
	Ambient humid.	35 to 85%RH, storage: 35 to 85%RH	
Protection structure	IP40 (front part, IEC standard)		
Approval	CE, C, UL US		
Weight*2	Approx. 122.2g (approx. 75g)		

※1: Refer to time specifications for control time setting range by model.

※2: The weight includes packaging. The weight in parenthesis is for unit only.

※Environment resistance is rated at no freezing or condensation.

## Unit Description

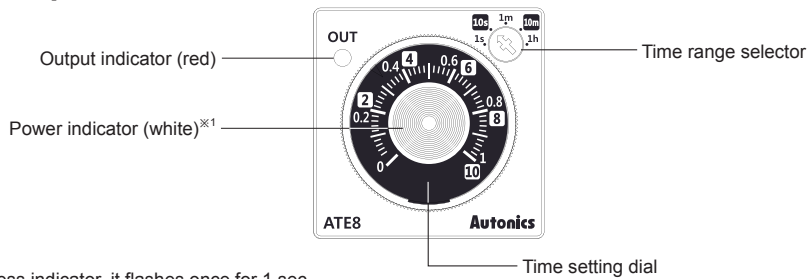

\*1: As time progress indicator, it flashes once for 1 sec.

## Time Specifications

Model	Time range	Time unit	Time setting range	Model	Time range	Time unit	Time setting range
ATE8-41□	1	s	0.1 to 1 sec	ATE8-46□	6	s	0.6 to 6 sec
	10		1 to 10 sec		60		6 to 60 sec
	1	m	0.1 to 1 min		6	m	0.6 to 6 min
	10		1 to 10 min		60		6 to 60 min
ATE8-43□	1	h	0.1 to 1 hour	ATE8-4C□	6	h	0.6 to 6 hour
	3		0.3 to 3 sec		12		s
	30	3 to 30 sec	12		m	1.2 to 12 min	
	3	m	0.3 to 3 min			24	m
30	3 to 30 min		12	h	1.2 to 12 hour		
3	h	0.3 to 3 hour	24		h	2.4 to 24 hour	

## Operation Mode

[t: Setting time, Rt: Return time]

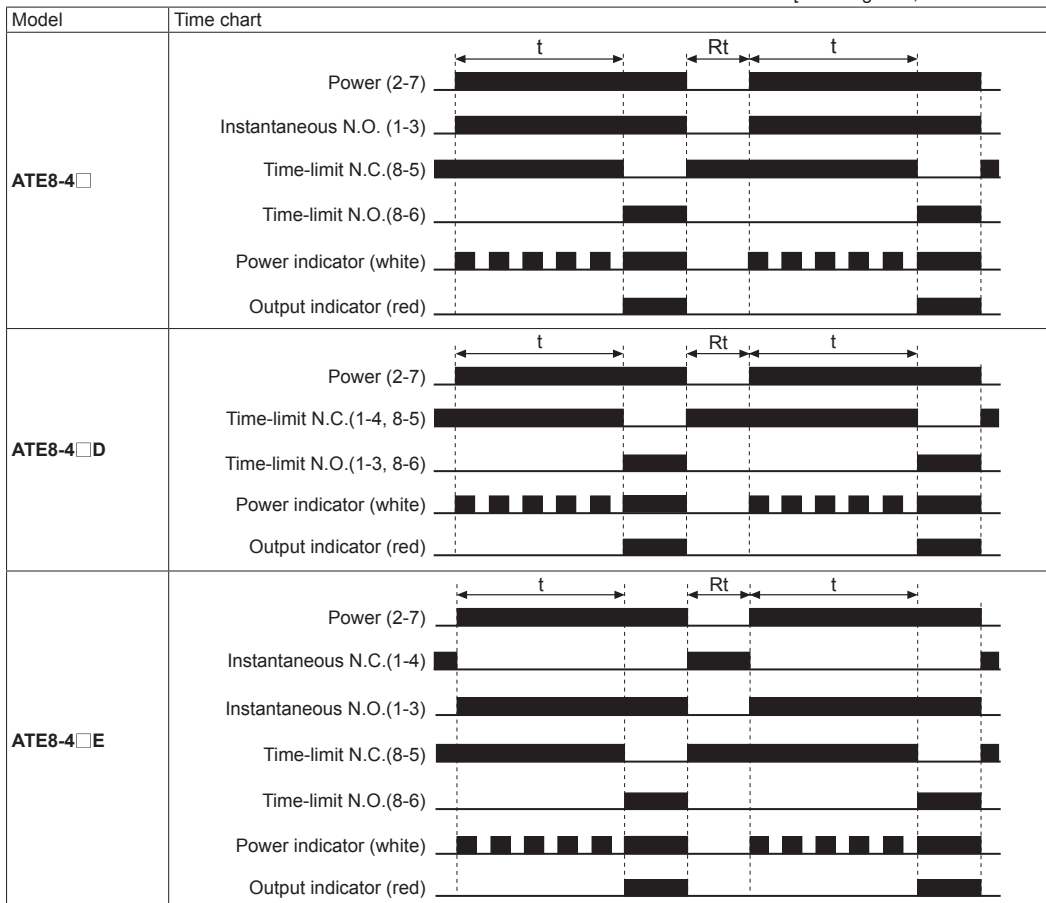

- (A) Photoelectric Sensors
- (B) Fiber Optic Sensors
- (C) Door/Area Sensors
- (D) Proximity Sensors
- (E) Pressure Sensors
- (F) Rotary Encoders
- (G) Connectors/ Connector Cables/ Sensor Distribution Boxes/Sockets
- (H) Temperature Controllers
- (I) SSRs / Power Controllers
- (J) Counters
- (K) Timers
- (L) Panel Meters
- (M) Tacho / Speed / Pulse Meters
- (N) Display Units
- (O) Sensor Controllers
- (P) Switching Mode Power Supplies
- (Q) Stepper Motors & Drivers & Controllers
- (R) Graphic/ Logic Panels
- (S) Field Network Devices
- (T) Software

# ATE8 Series

## Connections

### ● ATE8-4□

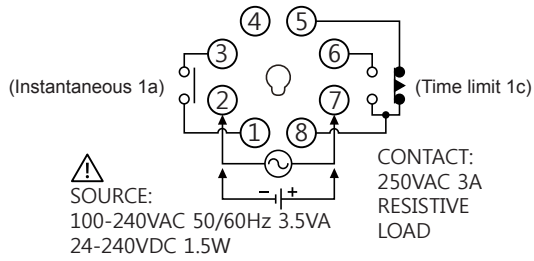

### ● ATE8-4□D

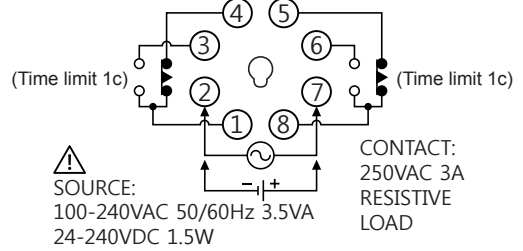

### ● ATE8-4□E

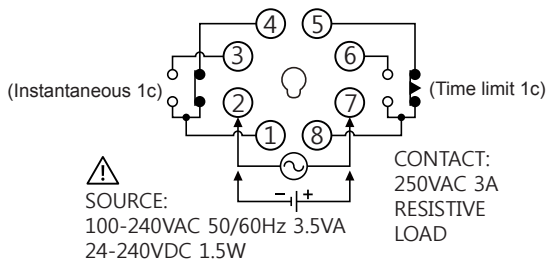

## Dimensions

(unit: mm)

※Nameplate design is changed and rear length is shorten than previous.

### ● Bracket (sold separately)(BK-S)

### ● Panel cut-out

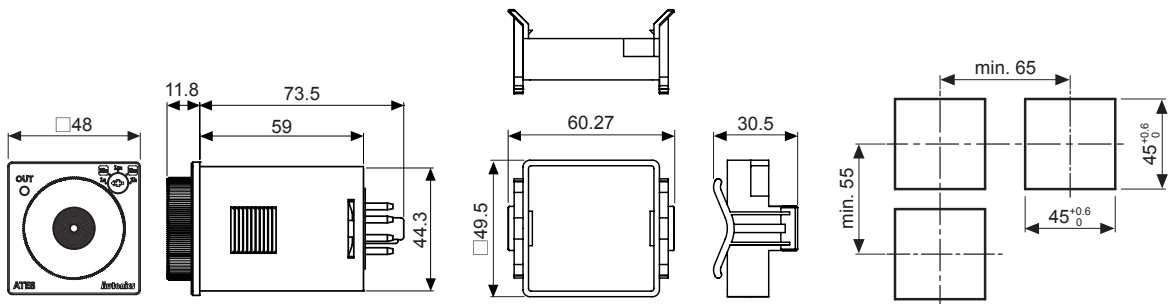

### ● Socket (sold separately)

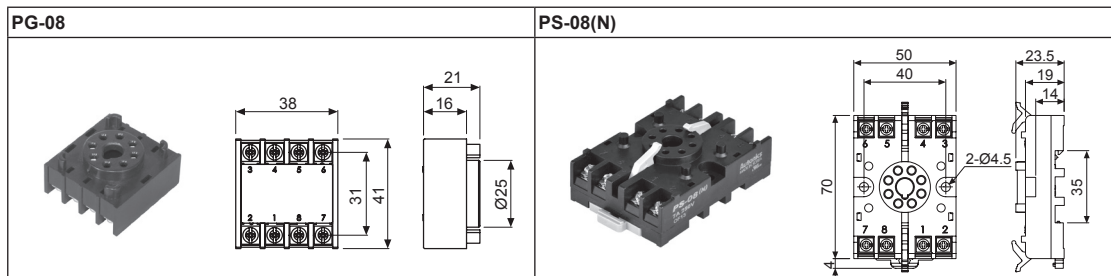

## ■ Proper Usage

- When supplying the power to the timer, use switch, or relay, etc for instant supply. When supplying power slowly, it may cause malfunction.
- When supply the power to the timer, connection shown in (Figure 1) might cause malfunction due to circuitous leakage current through resistance (R) and condenser (C). Please connect resistance (R) and condenser (C) as shown in (Figure 2) to prevent malfunction due to circuitous leakage current.

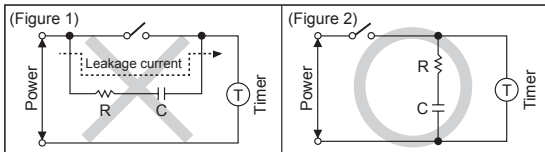

- Connect bipolar output contacts as potential.
- Testing dielectric voltage or insulation resistance when the unit is installed at control panel
  - ① Isolate the unit from the circuit of control panel.
  - ② Short all terminals of the unit.
- Do not use the unit in the following environments.
  - ① Environments with high vibration or shock.
  - ② Environments with strong alkali or strong acid materials
  - ③ Environments with exposure to direct sunlight
  - ④ Near machinery which produces strong magnetic force or electric noise
- This product may be used in the following environments.
  - ① Indoor
  - ② Altitude max. 2,000m
  - ③ Pollution degree 2
  - ④ Installation category II

(A) Photoelectric Sensors

(B) Fiber Optic Sensors

(C) Door/Area Sensors

(D) Proximity Sensors

(E) Pressure Sensors

(F) Rotary Encoders

(G) Connectors/ Connector Cables/ Sensor Distribution Boxes/Sockets

(H) Temperature Controllers

(I) SSRs / Power Controllers

(J) Counters

(K) Timers

(L) Panel Meters

(M) Tacho / Speed / Pulse Meters

(N) Display Units

(O) Sensor Controllers

(P) Switching Mode Power Supplies

(Q) Stepper Motors & Drivers & Controllers

(R) Graphic/ Logic Panels

(S) Field Network Devices

(T) Software

## ■ Proper Usage

- When supplying the power to the timer, use switch, or relay, etc for instant supply. When supplying power slowly, it may cause malfunction.
- When supply the power to the timer, connection shown in (Figure 1) might cause malfunction due to circuitous leakage current through resistance (R) and condenser (C). Please connect resistance (R) and condenser (C) as shown in (Figure 2) to prevent malfunction due to circuitous leakage current.

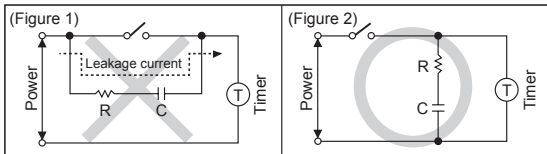

- Connect bipolar output contacts as potential.
- Testing dielectric voltage or insulation resistance when the unit is installed at control panel
  - ① Isolate the unit from the circuit of control panel.
  - ② Short all terminals of the unit.
- Do not use the unit in the following environments.
  - ① Environments with high vibration or shock.
  - ② Environments with strong alkali or strong acid materials
  - ③ Environments with exposure to direct sunlight
  - ④ Near machinery which produces strong magnetic force or electric noise
- This product may be used in the following environments.
  - ① Indoor
  - ② Altitude max. 2,000m
  - ③ Pollution degree 2
  - ④ Installation category II

(A) Photoelectric Sensors

(B) Fiber Optic Sensors

(C) Door/Area Sensors

(D) Proximity Sensors

(E) Pressure Sensors

(F) Rotary Encoders

(G) Connectors/ Connector Cables/ Sensor Distribution Boxes/Sockets

(H) Temperature Controllers

(I) SSRs / Power Controllers

(J) Counters

(K) Timers

(L) Panel Meters

(M) Tacho / Speed / Pulse Meters

(N) Display Units

(O) Sensor Controllers

(P) Switching Mode Power Supplies

(Q) Stepper Motors & Drivers & Controllers

(R) Graphic/ Logic Panels

(S) Field Network Devices

(T) Software