

ANALOG / DIGITAL TIMER

T38N / T48N / T57N / TF62N / TF62D

MA4N / LF4N / TT4



Leader in control and measurement industries –
HANYOUNG NUX CO.,LTD.

Analog & Digital Timer Series

- Plug-In type timers
- Up-grade version of pervious Analog and Digital Timers
- Apply convenient time set-up mode
- A wide power supply range
- Various Time ranges (Total 16 time ranges)
- Various operation charts (Total 6 operation charts)



Analog Timer MA4N

- Up grade version of MA4 model
- Apply convenient time set-up mode
- Free power voltages (24-240 V a.c 50/60, 24-240 V d.d)
- Various Time ranges (Total 16 time ranges)
- Various operation charts (Total 6 operation charts)
- A type (Time limit contact 2c), B type (Time limit contact 1c, Instantaneous contact 1c), C type (Time limit contact 2c or Time limit contact 1c, Instantaneous contact 1c)
- Use Power LED to display status of time process



Digital Timer LF4N

- LCD Display
- Up grade version of NF4 model
- Apply convenient time set-up mode
- Free power voltages (24-240 V a.c 50/60, 24-240 V d.d)
- Various Time ranges (Total 10 time ranges)
- Various operation charts (Total 10 operation charts)
- A type (Time limit contact 1c), B type (Time limit contact 1c, Instantaneous contact 1c), C type (Time limit contact 2c), D type (Time limit contact 1c)



Analog Timer T38N/T48N/T57N /TF62N/TF62D

- Up grade version of pervious Analog Timers (T38/T48/T57/T62)
- Apply MCU (Micro Control Unit) for precision time control
- Apply convenient time set-up mode
- Free power voltages (24-240 V a.c 50/60, 24-240 V d.d)
- Various time ranges (01, 03, 06, 10, 30, 60, 12)
- A type (Time limit contact 1c + Instantaneous contact 1a), B type (Time limit contact 1c + Instantaneous contact 1c), C type (Instantaneous contact 2c) + D type (Flicker), F type (Dual)
- Hour(H) / Minute(M) / Second(S) are particularly integrated
- Use Power LED to display status of time process



Digital Dual Timer TT4-P42A/P42B

- A wide power supply range (100-240 V a.c 50~60Hz)
- Plug-In type (8 pins and 11 pins)
- Various Time ranges (0.01 sec ~ 9999 hour)
- Available individual on-delay setting for 2 outputs
- Output operation control (Start, Rest, Inhibit) by outside input signal
- Can be used individual two timers
- Key-lock function to protect setting time value.

Analog Timer MA4N



- Up grade version of MA4 model
- Apply convenient time set-up mode
- Free power voltages (24-240 V a.c 50/60, 24-240 V d.c)
- Various Time ranges (Total 16 time ranges)
- Various operation charts (Total 6 operation charts)
- A type (Time limit contact 2c), B type (Time limit contact 1c, Instantaneous contact 1c), C type (Time limit contact 2c or Tim limit contact 1c, Instantaneous contact 1c)
- Use Power LED to display status of time process

Time range

Max. Time	Time Unit	sec	min	hrs	X10 h
Setting Range	1.2	0,12 ~ 1,2			1,2 ~ 12
	3	0,3 ~ 3			3 ~ 30
	12	1,2 ~ 12			12 ~ 120
	30	3 ~ 30			30 ~ 300

Selection of Time unit & Operation mode

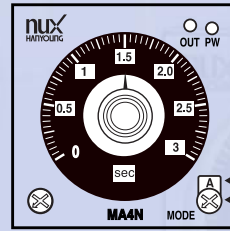

MA4N - A, MA4N - B TYPE

MODE	Function of operation
A	ON DELAY
B	FLICKER OFF START
C	INTERVAL
D	SIGNAL ON/OFF DELAY
E	SIGNAL OFF DELAY
F	FLICKER ON START

MA4N - C TYPE

MODE	Function of operation
A1	ON DELAY
B1	ON DELAY1
C1	ON DELAY2
D1	FLICKER OFF START
E1	FLICKER ON START
F1	INTERVAL



Digital Timer LF4N

- LCD Display
- Up grade version of NF4 model
- Apply convenient time set-up mode
- Free power voltages (24-240 V a.c 50/60, 24-240 V d.c)
- Various Time ranges (Total 10 time ranges)
- Various operation charts (Total 10 operation charts)
- A type (Time limit contact 1C), B type (Time limit contact 1C, Instantaneous contact 1c), C type (Time limit contact 2c), D type (Time limit contact 1c)

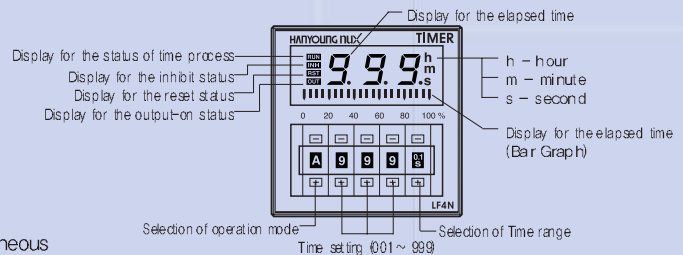

Function of operation chart

MODE	FUNCTION
A	SIGNAL ON-DELAY
B	FLICKER ON START
C	SIGNAL ON/OFF DELAY
D	SIGNAL OFF DELAY
E	INTERVAL
F	ONE SHOT & FLICKER
G	INTEGRATION
H	INTERVAL DELAY
I	FLICKER ONE-SHOT
J	POWER ON-START

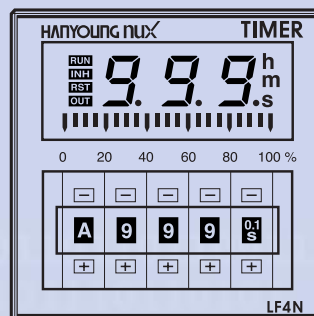

Function of Time units

Time unit	Time range
.01 s	0.01 s ~ 9.99 s
0.1 s	0.1 s ~ 99.9 s
s	1 s ~ 999 s
0.1 m	0.1 m ~ 99.9 m
m	1 m ~ 999 m
0.1 h	0.1 h ~ 99.9 h
h	1 h ~ 999 h
10 h	10 h ~ 9990 h
S	0 m 01 s ~ 9 m 59 s
M	0 h 01 m ~ 9 h 59 m

Analog Timer

T38N/T48N/T57N/ T62N/T62D



- Up grade version of pervious Analog Timers (T38/T48/T57/T62)
- Apply MCU (Micro Control Unit) for precision time control
- Apply convenient time set-up mode
- Free power voltages (24-240 V a.c 50/60, 24-240 V d.c)
- Various time ranges (01, 03, 06, 10, 30, 60, 12)
- A type (Time limit contact 1c + Instantaneous contact 1a), B type (Time limit contact 1c + Instantaneous contact 1c), C type (Instantaneous contact 2c) + D type (Flicker), F type (Dual)
- Hour(H) / Minute(M) / Second(S) are particularly integrated
- Use Power LED to display status of time process

Suffix Code

Suffix Code	Model	Description
	<input type="checkbox"/> <input type="checkbox"/> <input type="checkbox"/> <input type="checkbox"/>	Analog Timer
Model	T38N	48,0(W) × 59,0(H)mm
	T48N	48,0(W) × 48,0(H)mm
	T57N	'E' Size - 50,0(W) × 62,0(H)mm
	TF62N	'P' Size - 57,5(W) × 84,5(H)mm
Fixture type	E	Exposure type
	P	Panel type
Max. Time	1	1 sec / 1 min / 1 hour
	3	3 sec / 3 min / 3 hour
	6	6 sec / 6 min / 6 hour
	10	10 sec / 10 min / 10 hour
	30	30 sec / 30 min / 30 hour
	60	60 sec / 60 min / 60 hour
Output	12	12 hour / 24 hour / 48 hour (exception : TF62N & TF62D)
	A	Time limit contact 1c + Instantaneous contact 1a (T38,48,57N only)
	B	Time limit contact 1c + Instantaneous contact 1c (T38,48,57N only)
	C	Instantaneous contact 2c (T38,48,57N only)
	D	Instantaneous contact 1c (TF62N only)
	F	Instantaneous contact 2c (TF62D only)

Various contacts and operation charts

<p>■ A type (Time limit contact 1c + Instantaneous contact 1a)</p>	<p>POWER : 24-240 V[~] 50-60 Hz 24-240 V[~] 1.5 W</p> <p>CONTACT : 250 V a.c 3 A (RESISTIVE LOAD)</p>	
<p>■ B type (Time limit contact 1c + Instantaneous contact 1c)</p>	<p>POWER : 24-240 V[~] 50-60 Hz 24-240 V[~] 1.5 W</p> <p>CONTACT : 250 V a.c 3 A (RESISTIVE LOAD)</p>	
<p>■ C type (Instantaneous contact 2c)</p>	<p>POWER : 24-240 V[~] 50-60 Hz 24-240 V[~] 1.5 W</p> <p>CONTACT : 250 V a.c 3 A (RESISTIVE LOAD)</p>	
<p>■ D type (Instantaneous contact 1c)</p>	<p>POWER : 24-240 V[~] 50-60 Hz 24-240 V[~] 1.5 W</p> <p>CONTACT : 250 V a.c 3 A (RESISTIVE LOAD)</p>	
<p>■ F type (Instantaneous contact 2c)</p>	<p>POWER : 24-240 V[~] 50-60 Hz 24-240 V[~] 1.5 W</p> <p>CONTACT : 250 V a.c 3 A (RESISTIVE LOAD)</p>	

Digital Dual Timer

TT4-P42A/ P42B



- LCD Display
- Up grade version of NF4 model
- Apply convenient time set-up mode
- Free power voltages (24-240 V a.c 50/60, 24-240 V d.c)
- Various Time ranges (Total 10 time ranges)
- Various operation charts (Total 10 operation charts)
- A type (Time limit contact 1C), B type (Time limit contact 1C, Instantaneous contact 1c), C type (Time limit contact 2c), D type (Time limit contact 1c)

Suffix Code

Model	Model #						Contents	
	□	-	□	□	□	□		
Model	TT4						Digital Dual Timer, DIN Size 48(W) × 48(H)mm	
Type			P				Preset	
Digit				4			4 Digit (999)	
Stage					2		2 Stages	
Connection type							A	11 Pin Plug type
							B	8 Pin Plug type

Connections

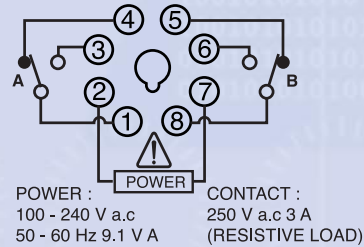
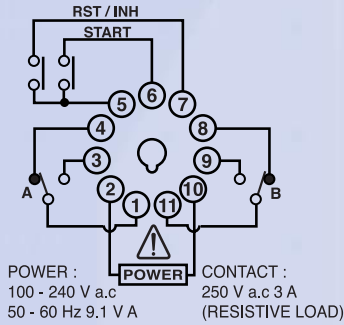

Specification of output operation mode

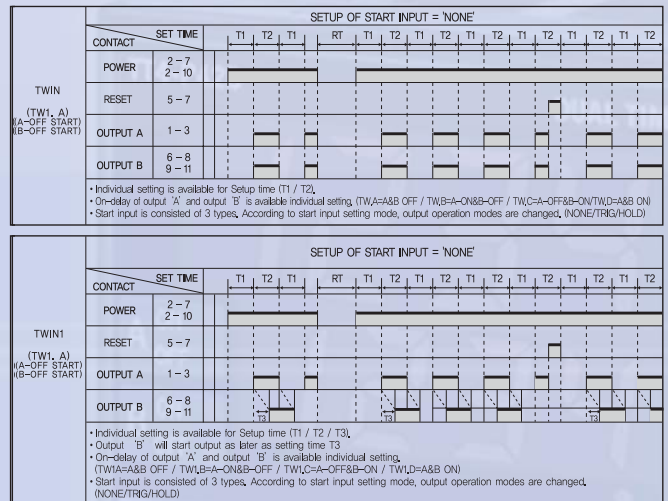
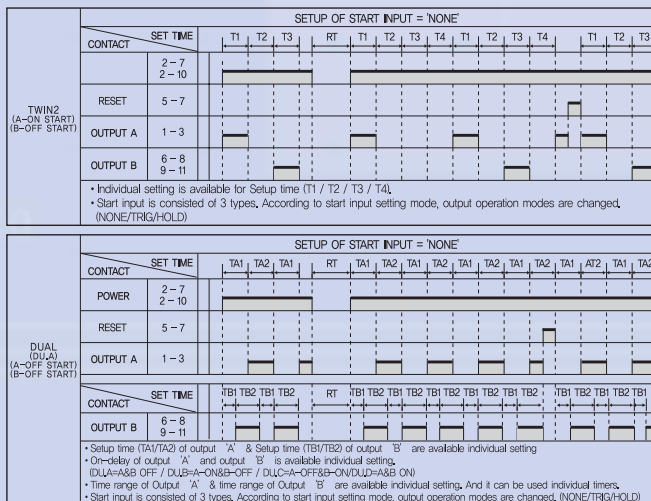



ANALOG / DIGITAL TIMER

**T38N / T48N / T57N / TF62N / TF62D
MA4N / LF4N / TT4**



Security or Safety International S.A. de C.V.

Torres IOS Campestre, Av. Ricardo Margain No. 575, C.P. 66267,
Parque Corporativo Santa Engracia, San Pedro Garza Garcia, N.L., México.

Tel: (01 81) 83597570 / 83588687

E-mail: ventas1@ssint.com.mx / soporte@ssint.com.mx

www.ssint.com.mx

www.hynux.net